



SPECIFICATION FOR TFT LCD MODULE

CUSTOMER : _____

CUSTOMER MODULE : _____

HG MODEL : HG101WX049

Preliminary Specification

Final Specification

Customer Confirmation column:

Approved by : _____ Dept. : _____ Date : _____

Please return one of the copies of the specification with your signature to us within two weeks after you receive this document. If it is not returned, we will assume that you agree to the entire contents of this specification document.

Designed by	Checked by	Approved by



Contents

No.	Items	Page
1.0	General Description	4
2.0	Absolute Maximum ratings	6
3.0	Electrical specifications.	7
4.0	Optical specifications.	9
5.0	Interface Connection	14
6.0	Signal Timing Specification	18
7.0	Input Signals, Display Colors & Gray Scale of Colors	22
8.0	Power Sequence	23
9.0	Connector description	24
10.0	Mechanical Characteristics	25
11.0	Reliability Test	26
12.0	Handling & Cautions.	26
13.0	Label	27
14.0	Packing information	29
15.0	Mechanical Outline Dimension	30
16.0	Flatness and thickness	32
17.0	EDID TAB	35



1.0 GENERAL DESCRIPTION

1.1 Introduction

10.1WXGA is a color active matrix TFT LCD module using amorphous silicon TFT's (Thin Film Transistors) as an active switching devices. This module has a 10.07 inch diagonally measured active area with WXGA resolutions (1280 horizontal by 800 vertical pixel array). Each pixel is divided into RED, GREEN, BLUE dots which are arranged in vertical stripe and this module can display 16.7M colors. The TFT-LCD panel used for this module is adapted for a low reflection and higher color type.

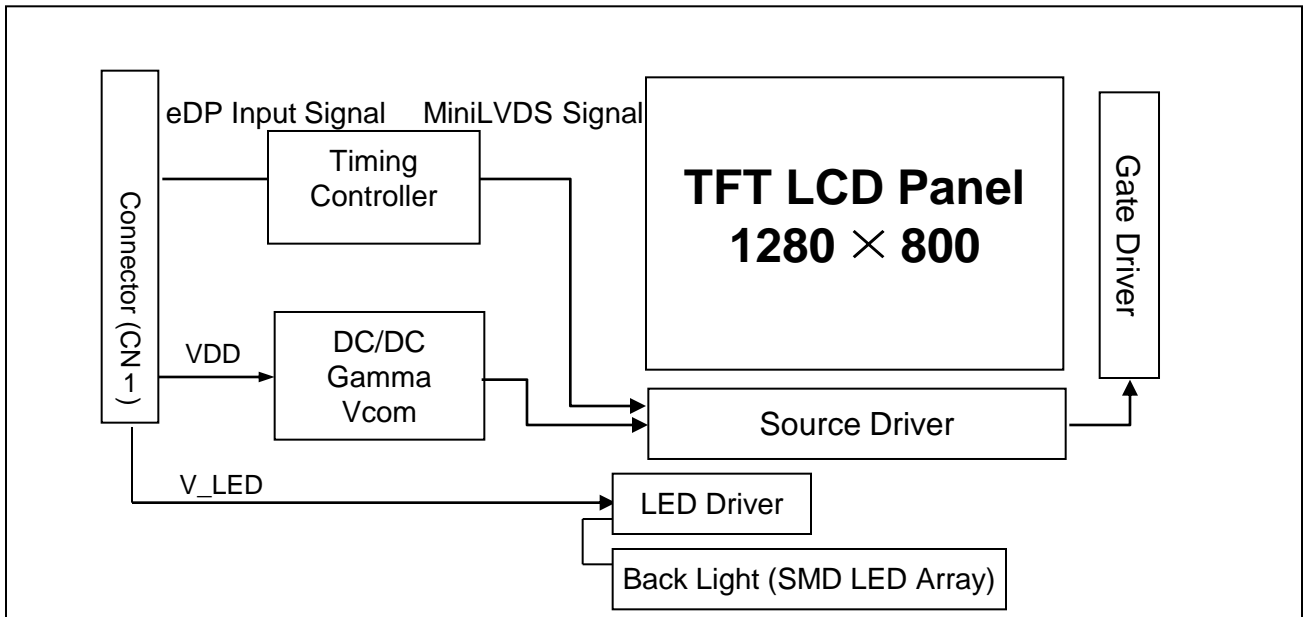

1.2 Features

- 1Lane eDP1.2 Interface
- Thin and light weight
- Display 16.7M colors (Hi FRC)
- High luminance and contrast ratio, low reflection and wide viewing angle
- 3.3V for Logic Power
- RoHS Compliant



1.3 Application

- Tablet

1.4 General Specification

< Table 1. General Specifications >

Parameter	Specification	Unit	Remarks
Active area	216.96(H) × 135.60(V)	mm	
Number of pixels	1280(H) × 800(V)	pixels	
Pixel pitch	56.5(H) × 169.5(V)	μm	
Pixel arrangement	Pixels RGB stripe arrangement		
Display colors	16.7M(6bits + Hi-FRC)	colors	
Display mode	Transmission mode. Normally Black		
Outline Dimension	228.3 × 149.05 × 2.4typ.	mm	
Weight	155(max)	gram	
Surface Treatment	HC Glare		
Back-light	Bottom edge side, 1-LED Lighting Bar Type		36* LED Array



2.0 ABSOLUTE MAXIMUM RATINGS

The followings are maximum values which, if exceed, may cause faulty operation or damage to the unit. The operational and non-operational maximum voltage and current values are listed in Table 2.

< Table 2. LCD Module Electrical Specifications > [Ta =25±2 °C]

Parameter	Symbol	Min.	Max.	Unit	Remarks
Power Supply Voltage	V_{DD}	-0.3	4.2	V	Note 1
Logic Supply Voltage	V_{IN}	$V_{SS}-0.3$	$V_{DD}+0.3$	V	
Operating Temperature	T_{OP}	-20	+60	°C	Note 2
Storage Temperature	T_{ST}	-20	+60	°C	

Note : 1) Temperature and relative humidity range are shown in the figure below.
Wet bulb temperature should be 39 °C max. and no condensation of water.

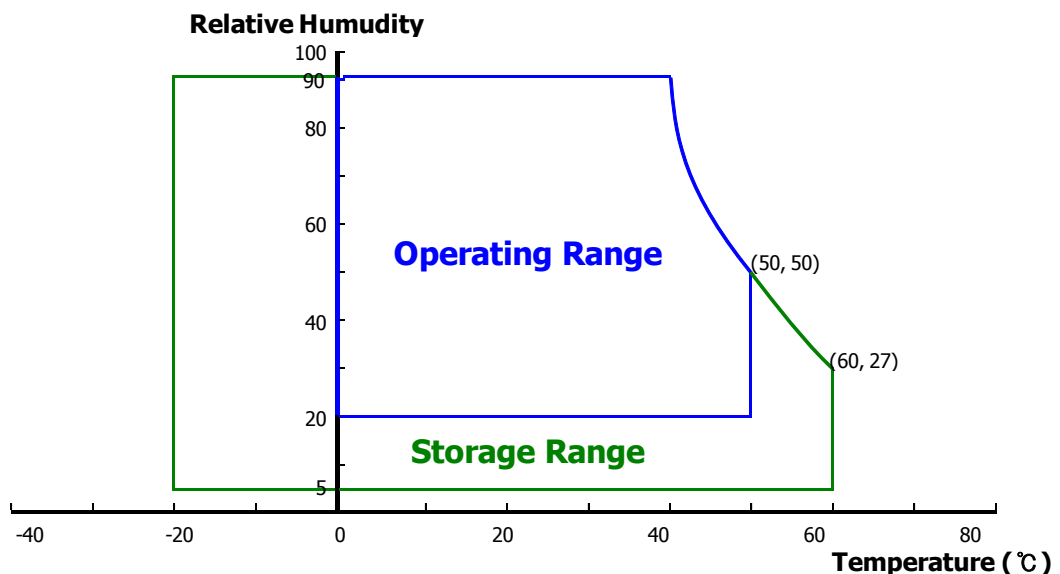



3.0 ELECTRICAL SPECIFICATIONS

3.1 TFT LCD Module

< Table 3. LCD Module Electrical Specifications >

[Ta =25±2 °C]

Parameter		Min.	Typ.	Max.	Unit	Remarks
Power Supply Voltage	V _{DD}	3.0	3.3	3.6	V	Note 1
Power Supply Current	I _{DD}	-	212	272	mA	Note 1
Positive-going Input Threshold Voltage	V _{IT+}	-	-	100	mV	V _{cm} = 1.2V typ.
Negative-going Input Threshold Voltage	V _{IT-}	-100	-	-	mV	
Differential Input Voltage	V _{ID}	380	-	1200	mV	
Power Consumption	P _D	-	0.7	0.9	W	white pattern
	P _{BL}	-	1.46	1.62	W	W/I Driver
	P _{total}	-	2.16	2.52	W	

Notes : 1. The supply voltage is measured and specified at the interface connector of LCM.
The current draw and power consumption specified is for 3.3V at 25 °C
Max value at White Pattern

2. Calculated value for reference (VLED X ILED)



3.2 Back-light Unit

< Table 4. LED Driving guideline specifications >

Ta=25+/-2°C

Parameter		Min.	Typ.	Max.	Unit	Remarks
LED Forward Voltage	V_F	-	2.9	3.0	V	-
LED Forward Current	I_F	-	14	15	mA	-
LED Power Consumption	P_{LED}	-	1.46	1.62	W	Note 1
LED Life-Time	N/A	15,000	-	-	Hour	IF = 14mA Note 2
Power supply voltage for LED Driver	V_{LED}	4.5	-	14	V	
EN Control Level	Backlight on	-	2.5	-	5.0	V
	Backlight off	-	0	-	1.0	V
PWM Control Level	PWM High Level	-	2.5	-	5.0	V
	PWM Low Level	-	0	-	0.1	V
PWM Control Frequency	F_{PWM}	200	-	2K	Hz	
Duty Ratio	-	5%	-	100%	%	

Notes : 1. Power supply voltage 12V for LED Driver, Driver efficiency 85%,
 Calculator Value for reference $I_F \times V_F \times 36 / 0.85 = P_{LED}$

2. The LED Life-time define as the estimated time to 50% degradation of initial luminous.



4.0 OPTICAL SPECIFICATION

4.1 Overview

The test of Optical specifications shall be measured in a dark room (ambient luminance ≤ 1 lux and temperature = $25 \pm 2^\circ\text{C}$) with the equipment of Luminance meter system (Goniometer system and TOPCON BM-5) and test unit shall be located at an approximate distance 50cm from the LCD surface at a viewing angle of θ and Φ equal to 0° . While scanning θ and/or Φ , the center of the measuring spot on the Display surface shall stay fixed. The backlight should be operating for 30 minutes prior to measurement. VDD shall be $3.3 \pm 0.3\text{V}$ at 25°C . Optimum viewing angle direction is 6 'clock.

4.2 Optical Specifications

<Table 5. Optical Specifications>

Parameter		Symbol	Condition	Min.	Typ.	Max.	Unit	Remark
Viewing Angle range	Horizontal	Θ_3	CR > 10	80	85	-	Deg.	Note 1
		Θ_9		80	85	-	Deg.	
	Vertical	Θ_{12}		80	85	-	Deg.	
		Θ_6		80	85	-	Deg.	
Color Gamut			45	50	-	%		
Luminance Contrast ratio		CR	$\Theta = 0^\circ$	600	800	-		Note 2
Luminance of White	5 Points	Y_w	$\Theta = 0^\circ$	250	300	-	cd/m ²	Note 3
White Luminance uniformity	13 Points	$\Delta Y5$		62.5	71.4	-		Note 4
White Chromaticity		W_x	$\Theta = 0^\circ$	Typ.	0.314	Typ. +0.03		Note 5
		W_y		-0.03	0.339			
Reproduction of color	Red	R_x	$\Theta = 0^\circ$	Typ. -0.03	0.589	Typ. +0.03		
		R_y			0.358			
	Green	G_x			0.332			
		G_y			0.567			
	Blue	B_x			0.156			
		B_y			0.116			
Response Time (Rising + Falling)		T_{RT}	Ta= 25°C $\Theta = 0^\circ$	-	30	-	ms	Note 6
Gamma Scale				2.0	2.2	2.4		
Cross Talk		CT	$\Theta = 0^\circ$	-	-	2.0	%	Note 7



- Notes : 1. Viewing angle is the angle at which the contrast ratio is greater than 10. The viewing angles are determined for the horizontal or 3, 9 o'clock direction and the vertical or 6, 12 o'clock direction with respect to the optical axis which is normal to the LCD surface (see FIGURE 1).
2. Contrast measurements shall be made at viewing angle of $\Theta = 0$ and at the center of the LCD surface. Luminance shall be measured with all pixels in the view field set first to white, then to the dark (black) state . (see FIGURE 1) Luminance Contrast Ratio (CR) is defined mathematically.

$$CR = \frac{\text{Luminance when displaying a white raster}}{\text{Luminance when displaying a black raster}}$$

3. Center Luminance of white is defined as luminance values of 5point average across the LCD surface. Luminance shall be measured with all pixels in the view field set first to white. This measurement shall be taken at the locations shown in FIGURE 2 for a total of the measurements per display, the LED current is set at 20mA.
4. The White luminance uniformity on LCD surface is then expressed as : $\Delta Y = \text{Minimum Luminance of 5 (13)points} / \text{Maximum Luminance of 5(13) (points)}$ (see FIGURE 3).
5. The color chromaticity coordinates specified in Table 5 shall be calculated from the spectral data measured with all pixels first in red, green, blue and white. Measurements shall be made at the center of the panel.
6. The electro-optical response time measurements shall be made as FIGURE 4 by switching the "data" input signal ON and OFF. The times needed for the luminance to change from 10% to 90% is T_r , and 90% to 10% is T_d .
7. Cross-Talk of one area of the LCD surface by another shall be measured by comparing the luminance (YA) of a 25mm diameter area, with all display pixels set to a gray level, to the luminance (YB) of that same area when any adjacent area is driven dark. (See FIGURE 5).



4.3 Optical measurements

Figure 1. Measurement Set Up

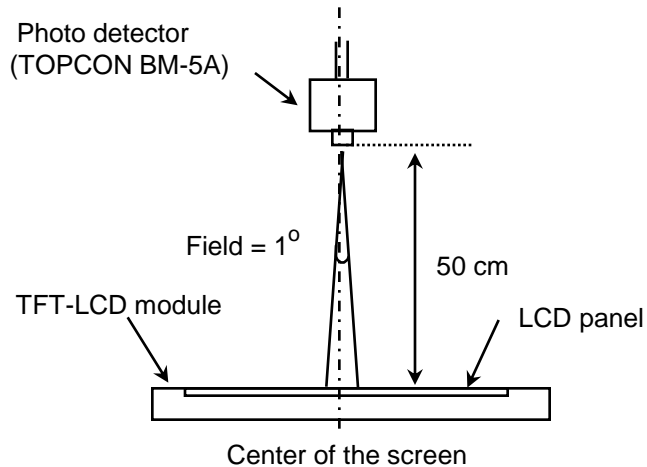

View angel range measurement setup

Figure 2. White Luminance and Uniformity Measurement Locations (5 points)

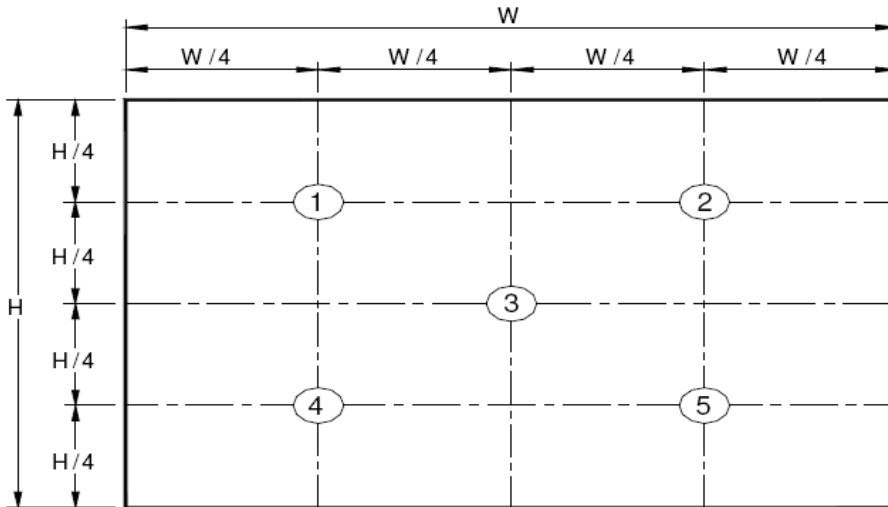

Center Luminance of white is defined as luminance values of center 5 points across the LCD surface. Luminance shall be measured with all pixels in the view field set first to white. This measurement shall be taken at the locations shown in FIGURE 2 for a total of the measurements per display.

The White luminance uniformity on LCD surface is then expressed as : $\Delta Y5 = \text{Minimum Luminance of 5 points} / \text{Maximum Luminance of 5points}$ (see FIGURE 2).



Figure 3. Uniformity Measurement Locations (13 points)

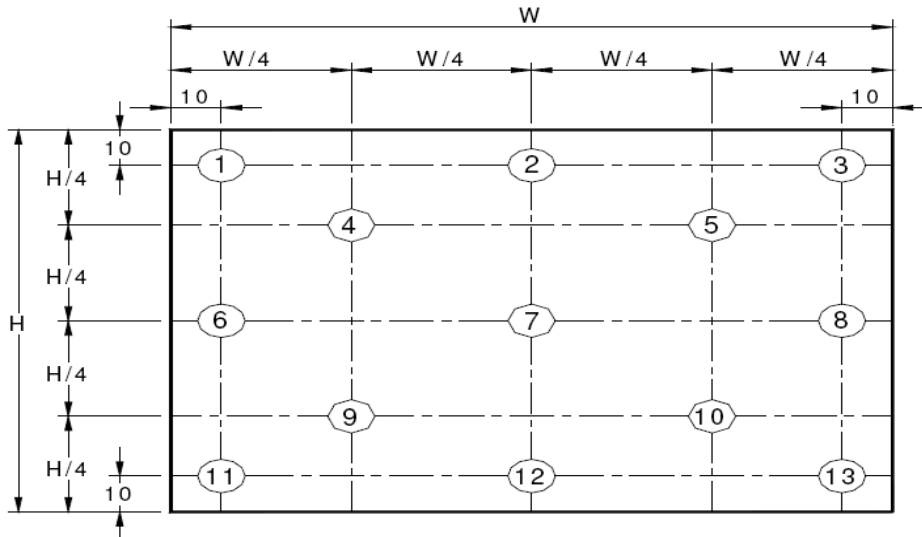

The White luminance uniformity on LCD surface is then expressed as : $\Delta Y_{13} = \text{Minimum Luminance of 13 points} / \text{Maximum Luminance of 13 points}$ (see FIGURE 3).

The White luminance uniformity of 5 point is the same test method as 13 point using FIGURE 2.

Figure 4. Response Time Testing

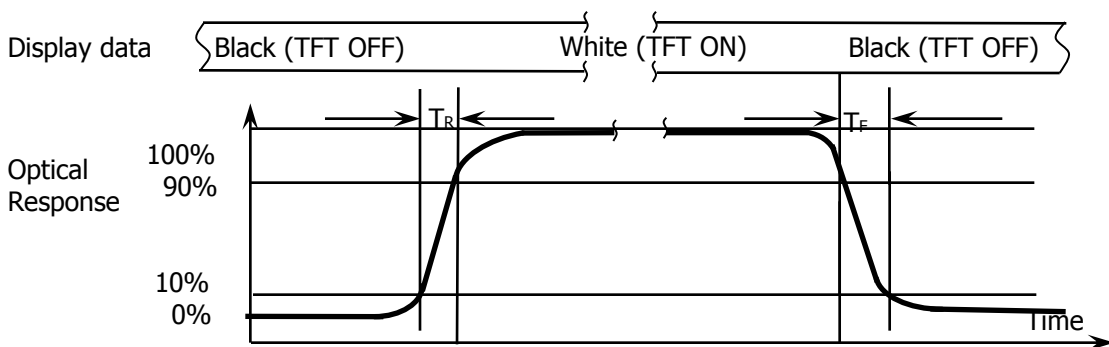

The electro-optical response time measurements shall be made as shown in FIGURE 4 by switching the “data” input signal ON and OFF. The times needed for the luminance to change from 10% to 90% is T_r and 90% to 10% is T_d .



Figure 5. Cross Modulation Test Description

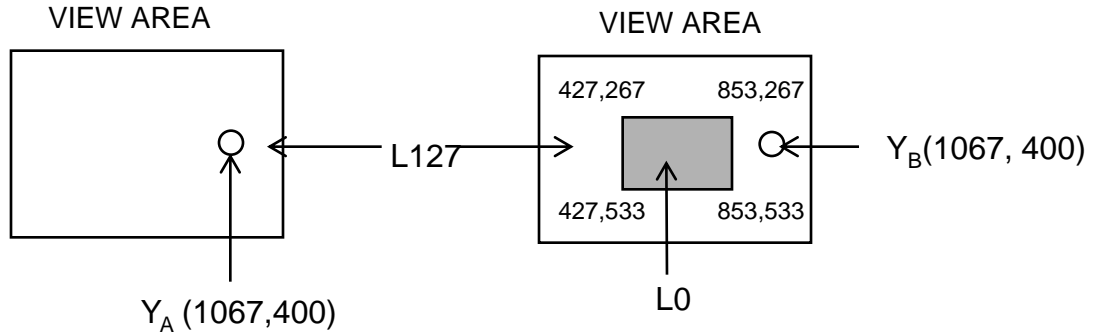

$$\text{Cross-Talk (\%)} = \left| \frac{Y_B - Y_A}{Y_A} \right| \times 100$$

Where:

Y_A = Initial luminance of measured area (cd/m²)

Y_B = Subsequent luminance of measured area (cd/m²)

The location measured will be exactly the same in both patterns.



5.0 INTERFACE CONNECTION.

5.1 Electrical Interface Connection

The electronics interface connector is MSAK24025P30.

The connector interface pin assignments are listed in Table 6 and 7.

<Table 6. Pin Assignments for the Interface Connector>

Terminal	Symbol	Functions
Pin No.	Symbol	Description
1	NC	NC
2	GND	Ground
3	NC	NC
4	NC	NC
5	GND	Ground
6	LANE0-N	eDP RX channel 0 negative
7	LANE0-P	eDP RX channel 0 positive
8	GND	Ground
9	AUX_CH_P	eDP AUX CH positive
10	AUX_CH_N	eDP AUX CH negative
11	GND	Ground
12	LCD_VCC	Power Supply, 3.3V
13	LCD_VCC	Power Supply, 3.3V
14	LCD_SELF_TEST	Aging Mode Power Supply
15	GND	Ground
16	GND	Ground
17	HPD	HPD
18	LED_GND	LED_GND
19	LED_GND	LED_GND
20	LED_GND	LED_GND



<Table 7. Pin Assignments for the Interface Connector>

Terminal	Symbol	Functions
Pin No.	Symbol	Description
21	LED_GND	LED_GND
22	LED_EN	LED_ENABLE
23	LED-PWM	LED PWMIN
24	NC	NC
25	NC	NC
26	VLED	LED Power Supply (4.5V - 14V)
27	VLED	LED Power Supply (4.5V - 14V)
28	VLED	LED Power Supply (4.5V - 14V)
29	VLED	LED Power Supply (4.5V - 14V)
30	NC	NC



5.2 EDP Input signal SPEC.

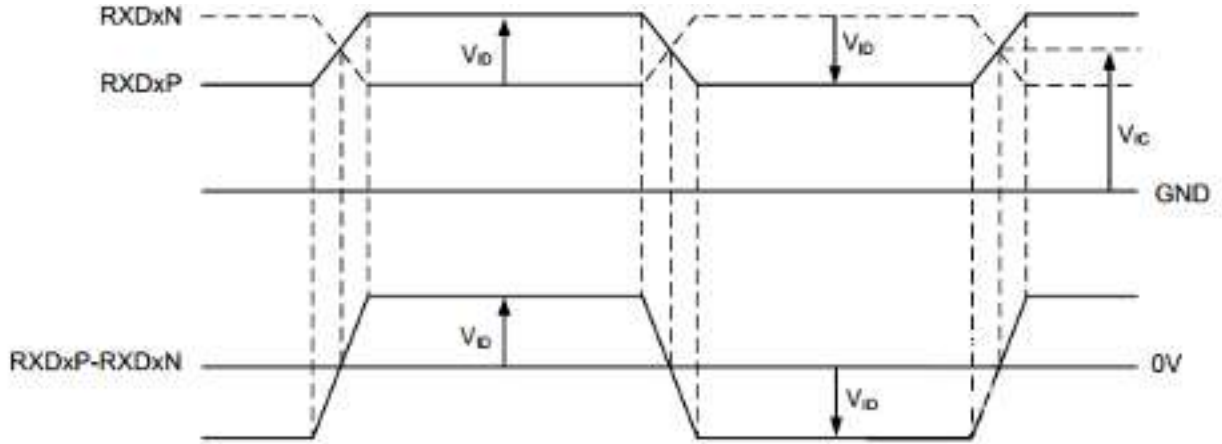

Main Link V_{ID} and V_{IC} definition

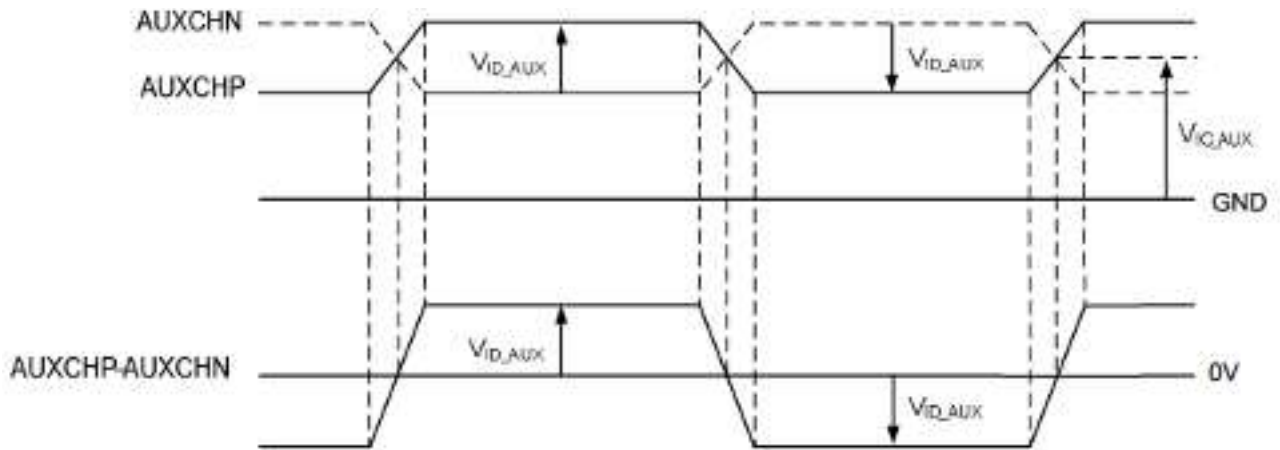

AUX CH V_{ID_AUX} and V_{IC_AUX} definition



5.3 Data Input Format

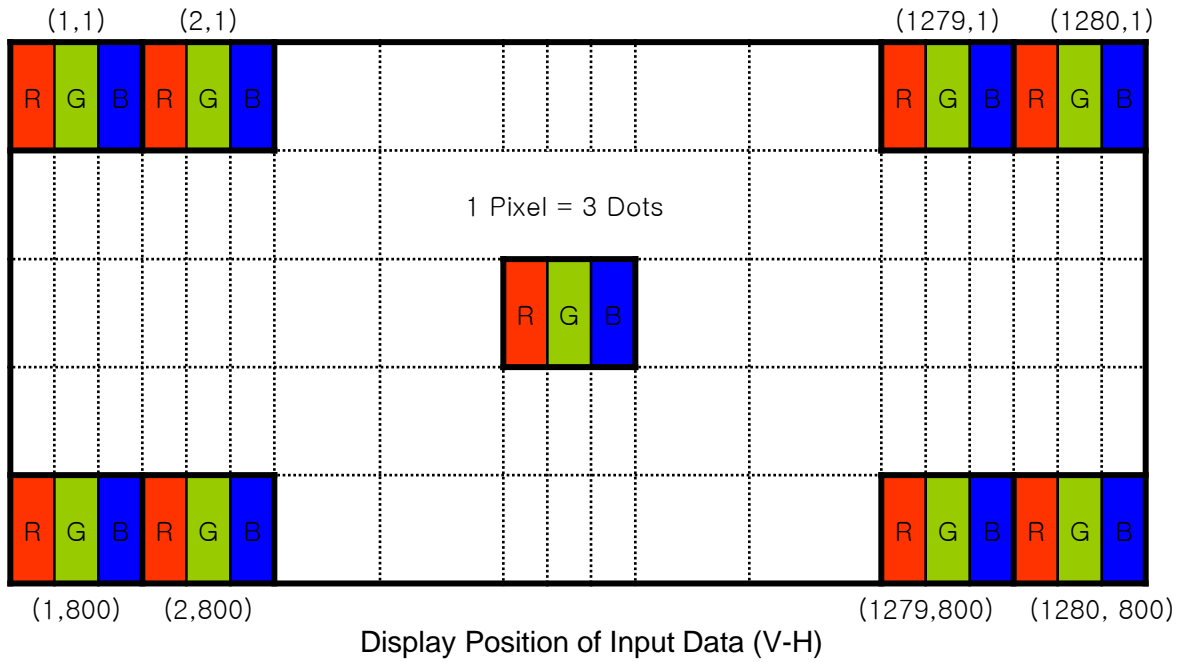



6.0 SIGNAL TIMING SPECIFICATION

6.1 Signal timing

ITEM	Symbol	Min	Typ	Max	Unit	Note
CLK	Period	t_{CLK}	4	-	4.44	ns
	Frequency	-	-	450	500	Mbps
Hsync	Period	t_{HP}	-	1330	-	t_{CLK}
	Frequency	f_H	-	48.72	-	KHz
Vsync	Period	t_{VP}	-	812	-	t_{HP}
	Frequency	f_V	55	60	64	Hz
Horizontal Active Display Term	Valid	t_{HV}	-	1280	-	t_{CLK}
	Total	t_{HP}	1350	1516	1560	t_{CLK}
Vertical Active Display Term	Valid	t_{VV}	-	800	-	t_{HP}
	Total	t_{VP}	830	831	860	t_{HP}

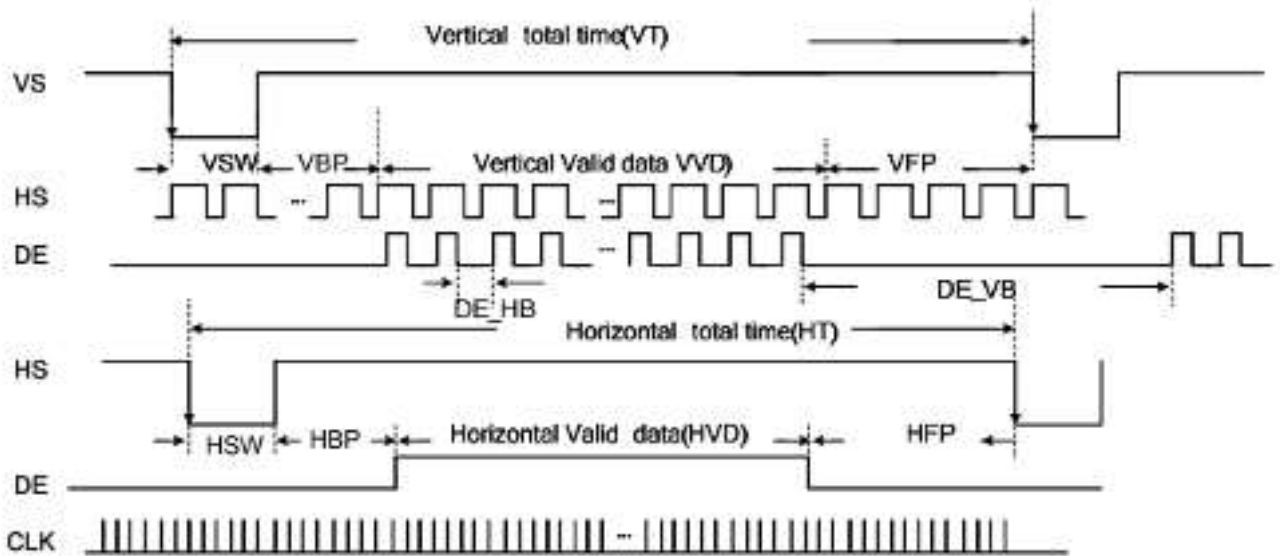

Figure 6.5: Input video signal format



6.2 EDP Interface Timing Parameter

The specification of the EDP interface timing parameter is shown in Table 8.

<Table 8. EDP Interface Timing Specification>

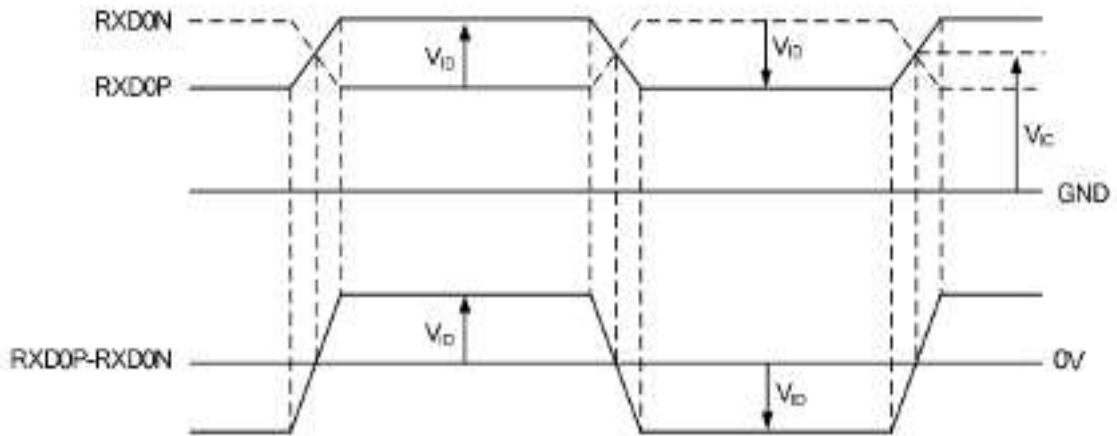
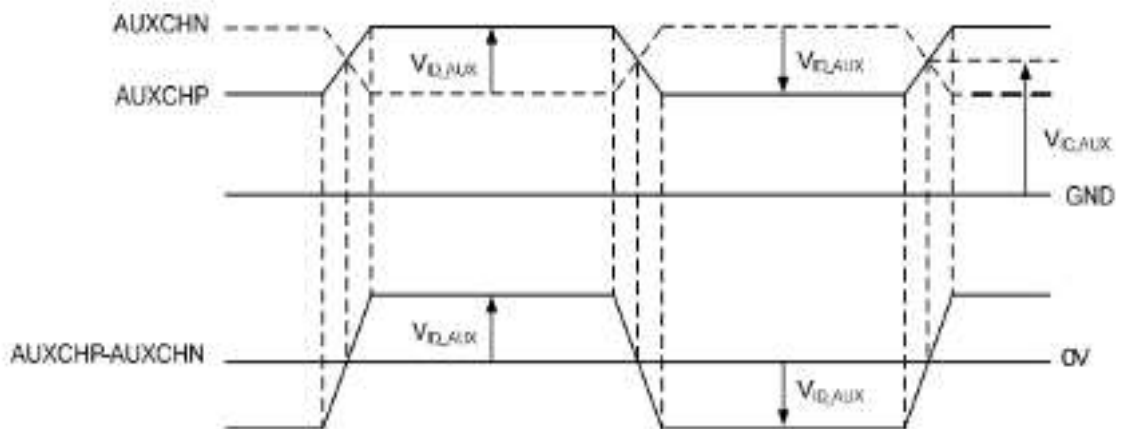

Figure 7.1: Main Link V_{ID} and V_{IC} definition





DC electrical character

Symbol	Parameter	Condition	Spec.			Unit
			Min.	Typ.	Max.	
CMOS/TTL DC specifications						
V_{IH}	High level input voltage	-	0.7VDDIO	-	VDDIO	V
V_{IL}	Low level input voltage	-	VSSIO	-	0.3VDDIO	V
V_{OH}	High level output voltage	-	0.8VDDIO	-	VDDIO	V
V_{OL}	Low level output voltage	-	VSSIO	-	0.2VDDIO	V
I_{IN}	Input current	-	-10	-	10	μ A
R_{PD}	Pull low resistance	CABC_EN (Pin 5) COLOR_EN (Pin 6) AGMODE (Pin 17) PWM1 (Pin 18) TEST (Pin 22)	75	150	225	K Ω
DP DC specifications						
V_{IC}	Main link common mode voltage - 0 - 2.0 V					
V_{ID}	Main link swing voltage	2.7 Gbps	± 60	-	± 600	mV
		1.62 Gbps	± 20	-	± 600	mV
V_{ID_AUX}	AUX common mode voltage	-	0	-	2.0	V
V_{ID_AUX}	AUX swing voltage	transmitting	± 0.195	-	± 0.69	V
		receiving	± 0.16	-	± 0.68	V
mini-LVDS DC specifications						
V_{OD}	Output differential voltage range	RL=100 Ω (T _A =25 $^{\circ}$ C)	100	-	600	mV
	Output differential voltage deviation		$V_{OD_CODE} \pm 0.85^{(1)}$	-	$V_{OD_CODE} \pm 1.15^{(1)}$	mV
V_{OS}	Output offset voltage range		0.6	-	1.3	V
	Output offset voltage deviation		$V_{OS_CODE} - 0.2^{(1)}$	-	$V_{OS_CODE} + 0.2^{(1)}$	V
PWM DC specifications						
V_{LX}	LX pin spike voltage	-	-2	-	3.6	V

Note: (1) The V_{OD_CODE} and V_{OS_CODE} can be programmable by different panel characteristics through ROM code.



AC electrical character

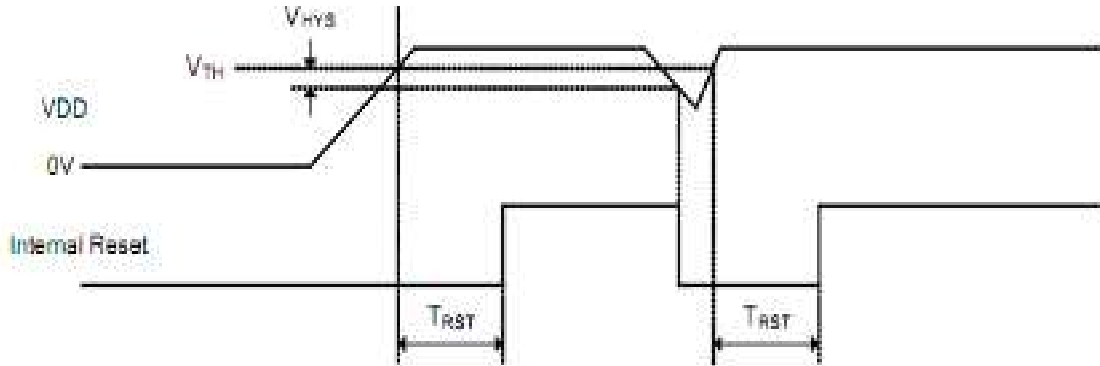

Figure : Power on reset

Symbol	Parameter	Condition	Spec.			Unit
			Min.	Typ.	Max.	
V_{TH}	Reset threshold voltage	-	1.7	1.9	2.1	V
V_{HYS}	Hysteresis voltage	-	200	-	-	mV
T_{RST}	Time constant of RC	-	-	0.6RC	-	s

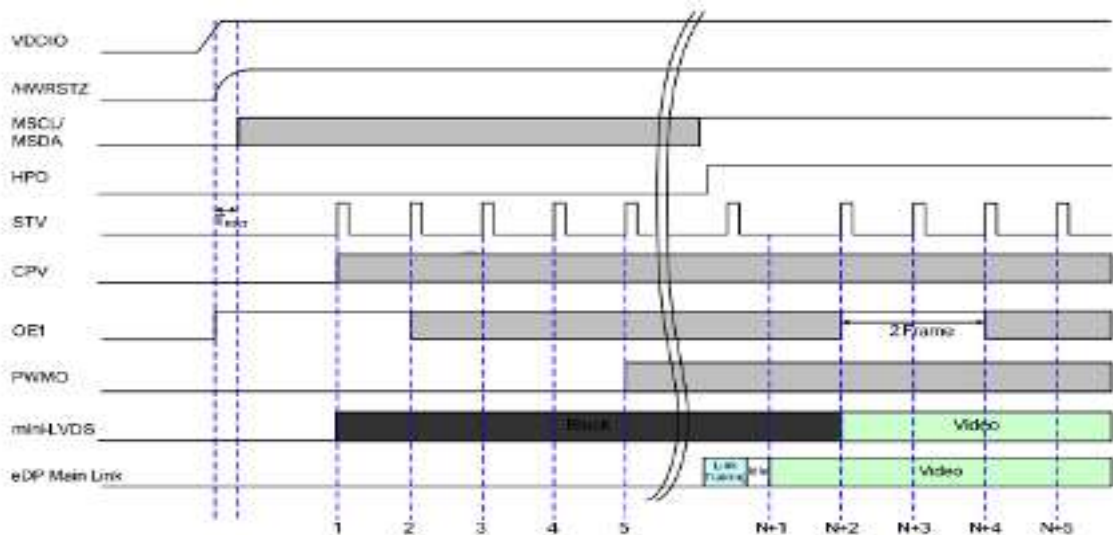

Figure : Power up sequence



7.0 INPUT SIGNALS, BASIC DISPLAY COLORS & GRAY SCALE OF COLORS

Color & Gray Scale		Input Data Signal																							
		Red Data								Green Data								Blue Data							
		R7	R6	R5	R4	R3	R2	R1	R0	G7	G6	G5	G4	G3	G2	G1	G0	B7	B6	B5	B4	B3	B2	B1	B0
Basic Colors	Black	0	0	0	0	0	0	0	0	0	0	0	0	0	0	0	0	0	0	0	0	0	0	0	
	Blue	0	0	0	0	0	0	0	0	0	0	0	0	0	0	0	0	1	1	1	1	1	1	1	
	Green	0	0	0	0	0	0	0	0	1	1	1	1	1	1	1	1	0	0	0	0	0	0	0	
	Cyan	0	0	0	0	0	0	0	0	1	1	1	1	1	1	1	1	1	1	1	1	1	1	1	
	Red	1	1	1	1	1	1	1	1	0	0	0	0	0	0	0	0	0	0	0	0	0	0	0	
	Magenta	1	1	1	1	1	1	1	1	0	0	0	0	0	0	0	0	1	1	1	1	1	1	1	
	Yellow	1	1	1	1	1	1	1	1	1	1	1	1	1	1	1	1	0	0	0	0	0	0	0	
	White	1	1	1	1	1	1	1	1	1	1	1	1	1	1	1	1	1	1	1	1	1	1	1	
Gray Scale of Red	Black	0	0	0	0	0	0	0	0	0	0	0	0	0	0	0	0	0	0	0	0	0	0		
	△	0	0	0	0	0	0	0	1	0	0	0	0	0	0	0	0	0	0	0	0	0	0		
	Darker	0	0	0	0	0	0	1	0	0	0	0	0	0	0	0	0	0	0	0	0	0	0		
	△	↑								↑								↑							
	▽	↓								↓								↓							
	Brighter	1	1	1	1	1	1	0	1	0	0	0	0	0	0	0	0	0	0	0	0	0	0	0	
	▽	1	1	1	1	1	1	1	0	0	0	0	0	0	0	0	0	0	0	0	0	0	0	0	
	Red	1	1	1	1	1	1	1	1	0	0	0	0	0	0	0	0	0	0	0	0	0	0	0	
Gray Scale of Green	Black	0	0	0	0	0	0	0	0	0	0	0	0	0	0	0	0	0	0	0	0	0	0		
	△	0	0	0	0	0	0	0	0	0	0	0	0	0	0	0	1	0	0	0	0	0	0		
	Darker	0	0	0	0	0	0	0	0	0	0	0	0	0	0	1	0	0	0	0	0	0	0		
	△	↑								↑								↑							
	▽	↓								↓								↓							
	Brighter	0	0	0	0	0	0	0	0	1	1	1	1	1	1	0	1	0	0	0	0	0	0	0	
	▽	0	0	0	0	0	0	0	0	1	1	1	1	1	1	1	0	0	0	0	0	0	0	0	
	Green	0	0	0	0	0	0	0	0	1	1	1	1	1	1	1	1	0	0	0	0	0	0	0	
Gray Scale of Blue	Black	0	0	0	0	0	0	0	0	0	0	0	0	0	0	0	0	0	0	0	0	0	0		
	△	0	0	0	0	0	0	0	0	0	0	0	0	0	0	0	0	0	0	0	0	0	1		
	Darker	0	0	0	0	0	0	0	0	0	0	0	0	0	0	0	0	0	0	0	0	0	1		
	△	↑								↑								↑							
	▽	↓								↓								↓							
	Brighter	0	0	0	0	0	0	0	0	0	0	0	0	0	0	0	0	1	1	1	1	1	1	0	
	▽	0	0	0	0	0	0	0	0	0	0	0	0	0	0	0	0	1	1	1	1	1	1	0	
	Blue	0	0	0	0	0	0	0	0	0	0	0	0	0	0	0	0	1	1	1	1	1	1	1	
Gray Scale of White	Black	0	0	0	0	0	0	0	0	0	0	0	0	0	0	0	0	0	0	0	0	0	0		
	△	0	0	0	0	0	0	0	1	0	0	0	0	0	0	0	1	0	0	0	0	0	0		
	Darker	0	0	0	0	0	0	1	0	0	0	0	0	0	0	1	0	0	0	0	0	0	0		
	△	↑								↑								↑							
	▽	↓								↓								↓							
	Brighter	1	1	1	1	1	1	0	1	1	1	1	1	1	1	0	1	1	1	1	1	1	0	1	
	▽	1	1	1	1	1	1	1	0	1	1	1	1	1	1	1	0	1	1	1	1	1	1	0	
	White	1	1	1	1	1	1	1	1	1	1	1	1	1	1	1	1	1	1	1	1	1	1	1	



8.0 POWER SEQUENCE

To prevent a latch-up or DC operation of the LCD module, the power on/off sequence shall be as shown in below

Power-On/Off Timing Sequence:

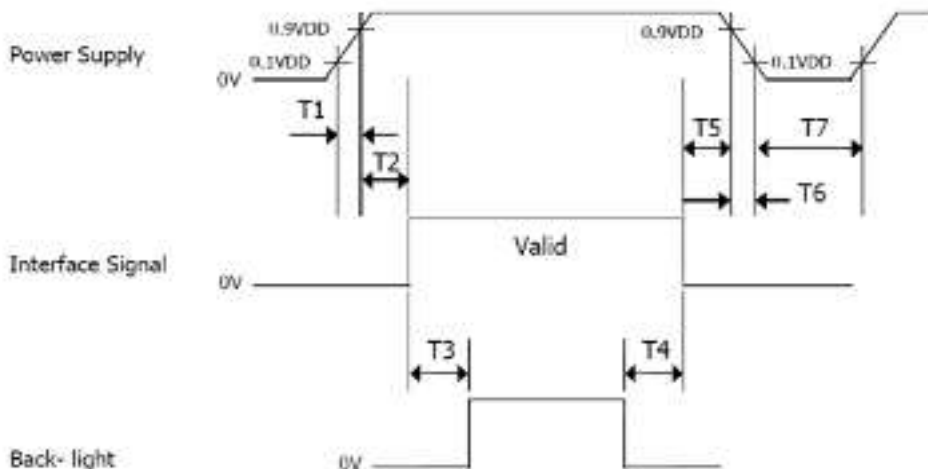

Parameter	Values			Units
	Min	Typ	Max	
T1	0	-	10	ms
T2	0	-	50	ms
T3	200	-	-	ms
T4	200	-	-	ms
T5	0.5	-	50	ms
T6	0	-	10	ms
T7	500	-	-	ms

Notes:

1. When the power supply VDD is 0V, keep the level of input signals on the low or keep high impedance.
2. Do not keep the interface signal high impedance when power is on. Back Light must be turn on after power for logic and interface signal are valid.



9.0 CONNECTOR DESCRIPTION

Physical interface is described as for the connector on LCM.

These connectors are capable of accommodating the following signals and will be following components.

9.1 TFT LCD Module

Connector Name /Description	For Signal Connector
Manufacturer	STM or Compatible
Type/ Part Number	MSAK24025P30 or Compatible



10.0 MECHANICAL CHARACTERISTICS

10.1 Dimensional Requirements

FIGURE 5 shows mechanical outlines for the model HG101WX049.
Other parameters are shown in Table 9.

<Table 9. Dimensional Parameters>

Parameter	Specification	Unit
Active Area	216.96 (H) × 135.6 (V)	
Number of pixels	1280(H) X800 (V) (1 pixel = R + G + B dots)	
Pixel pitch	0.1695	
Pixel arrangement	RGB Vertical stripe	
Display colors	16.7M	
Display mode	Normally Black	
Dimensional outline	228.3 X 149.05 X 2.4(Typ.)	mm
Weight	155 (Max)	gram
Back-light	LED, Horizontal-LED Array type	

10.2 Mounting

See FIGURE 6.

10.3 Glare and Polarizer Hardness.

The surface of the LCD has an low reflection coating and hard coating to reduce scratching.

10.4 Light Leakage

There shall not be obvious visible light from the back-lighting system around the edges of the screen as seen from a distance 50cm from the screen with an overhead light level of 150lux.



11.0 RELIABILITY TEST

The Reliability test items and its conditions are shown in below.

<Table 10. Reliability test>

No		Conditions
1	High temperature storage test	Ta = 60 °C, 240 hrs
2	Low temperature storage test	Ta = -20 °C, 240 hrs
3	High temperature & high humidity operation test	Ta = 60 °C, 90%RH, 240 hrs
4	High temperature operation test	Ta = 60 °C, 240 hrs
5	Low temperature operation test	Ta = -20 °C, 240 hrs
6	Thermal shock	Ta = -20 °C ↔ 60 °C (0.5 hr), 100 cycle
7	Power on/off	10s on/10s off 20000cycles
8	Vibration test (non-operating)	1.47G, 10~200Hz Sign ±X, ±Y, ±Z / Sweep rate : 0.5hour
9	Shock test (non-operating)	220G, Half Sine Wave 2msec ±X, ±Y, ±Z Once for each direction
10	Electro-static discharge test (non-operating)	Air : 150 pF, 330Ω, ± 8 KV Contact : 150 pF, 330Ω, ± 4 KV
11	Image Sticking	25°C, Chess 5*5, 1hr, L127, 5min消失

12.0 HANDLING & CAUTIONS

(1) Cautions when taking out the module

- Pick the pouch only, when taking out module from a shipping package.

(2) Cautions for handling the module

- As the electrostatic discharges may break the LCD module, handle the LCD module with care. Peel a protection sheet off from the LCD panel surface as slowly as possible.
- As the LCD panel and back - light element are made from fragile glass material, impulse and pressure to the LCD module should be avoided.
- As the surface of the polarizer is very soft and easily scratched, use a soft dry cloth without chemicals for cleaning.
- Do not pull the interface connector in or out while the LCD module is operating.
- Put the module display side down on a flat horizontal plane.
- Handle connectors and cables with care.

(3) Cautions for the operation

- When the module is operating, do not lose CLK, ENAB signals. If any one of these signals is lost, the LCD panel would be damaged.
- Obey the supply voltage sequence. If wrong sequence is applied, the module would be damaged.



9.0 PRODCUT SERIAL NUMBER



标签尺寸: 48mm × 12mm, 厚度0.075mm

1. FG-CODE: HG101WX049
2. MDL ID 对应条形码
3. MDL ID

MDL ID Naming Rule:

序列号	1	2	3	4	5	6	7	8	9	10	11	12	13	14	15	16	17
代码	X	X	X	3	X	X	X	3	8	5	0	X	X	X	X	X	X
描述	GBN代码		等级	B3	年份		月	HG Code后四位				序列号					



10.0 PACKING INFORMATION

HG provides the standard shipping container for customers, unless customer specifies their packing information. The standard packing method and Barcode information are shown in below.

10.1 Packing Order

- 将 2pcs LCM平放入Tray, Panel向上放置;
- 产品上放1pcs垫片

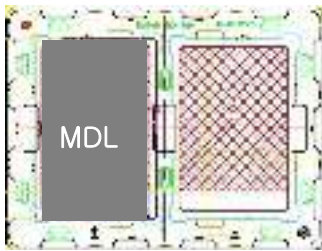

- 将21pcs PET Tray 平放入PE Bag
- Tray 无需旋转码放
- 顶部1pcs 空Tray

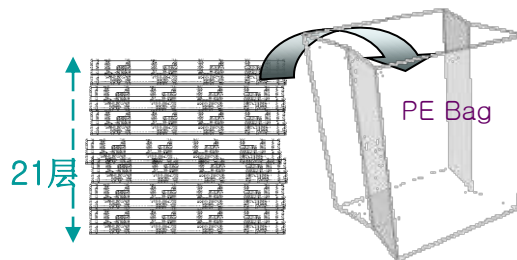

- 将PET Tray堆码后平放入Inner Box
- 上下放置EPE Board
- 40pcs/Box

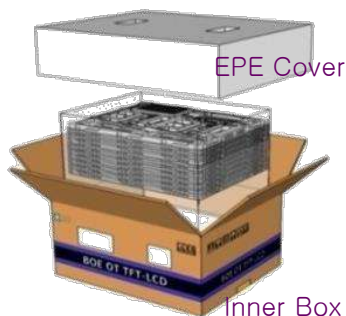

- 每个Pallet上放3层Box
- 1层4箱,共计12ea Box
- Pallet外进行缠膜包装
- 480pcs Panel / Pallet

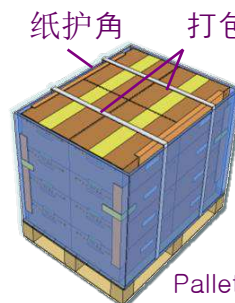



10.2 Packing Note

- Box Dimension : 500mm(L)×400mm(W)×290mm(H)
- Package Quantity in one Box : 40pcs



15.0 MECHANICAL OUTLINE DIMENSION

Figure 6. TFT-LCD Module Outline Dimension (Front View)

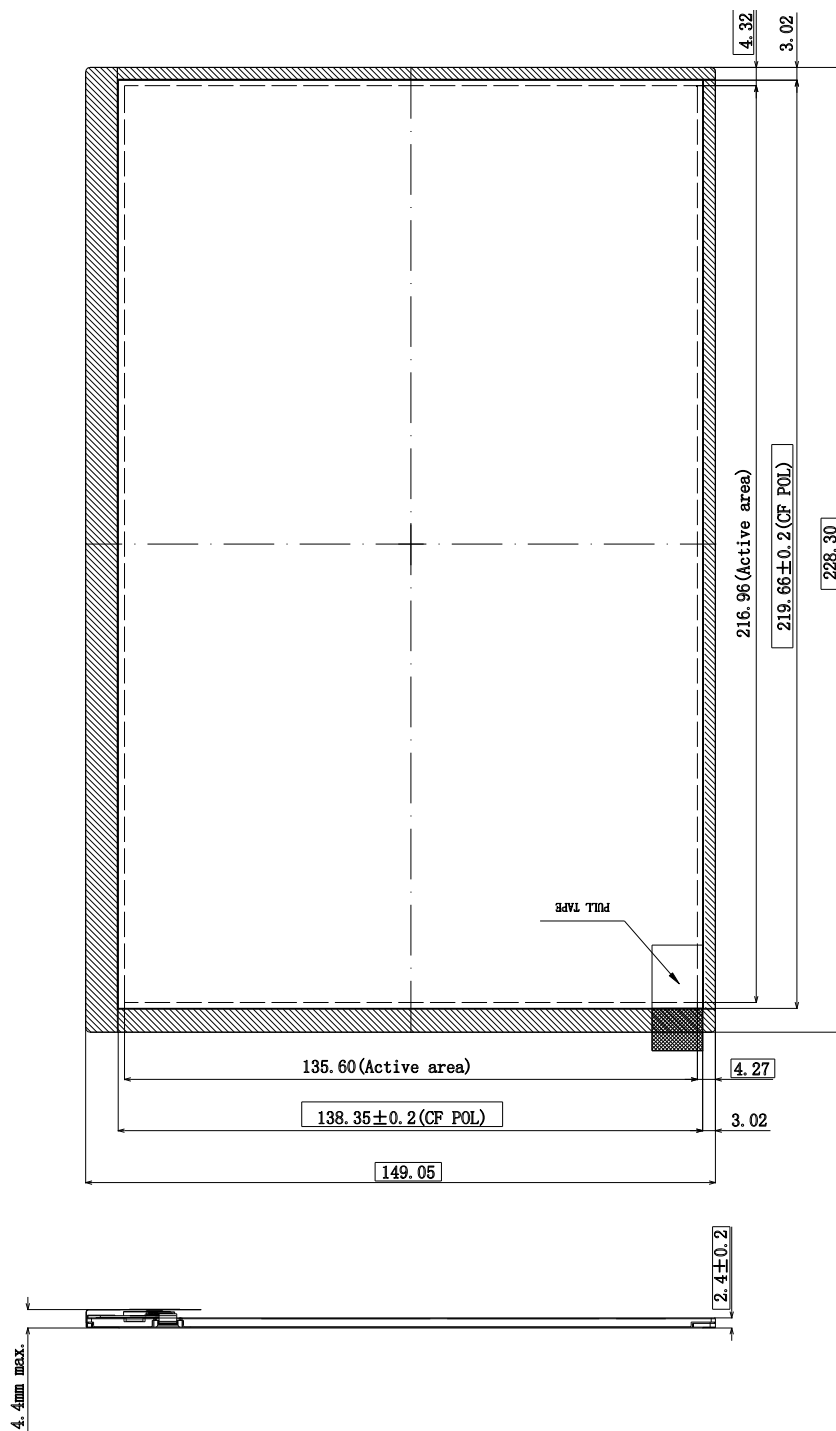
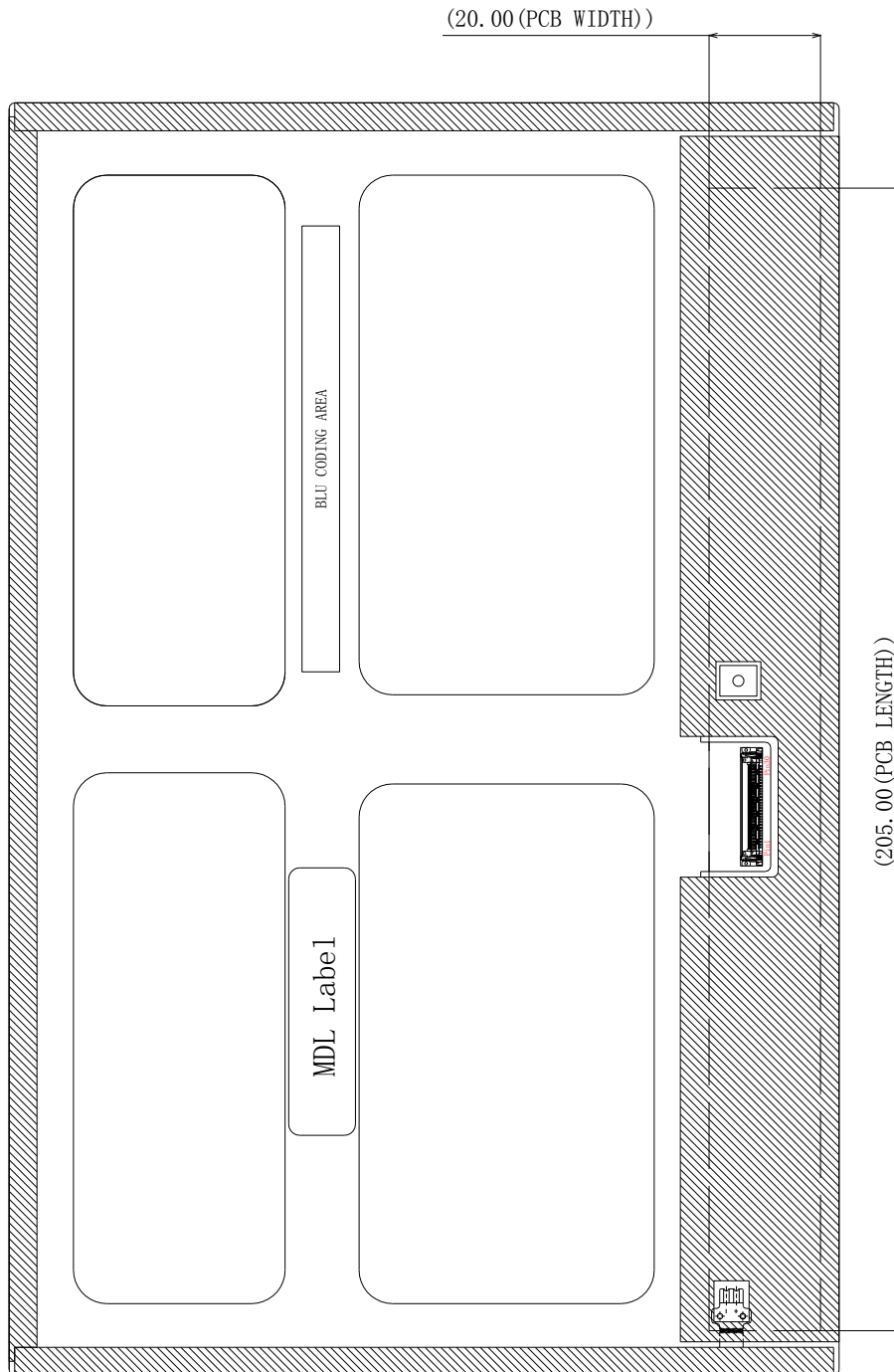



Figure 7. TFT-LCD Module Outline Dimensions (Rear view)





16.0 FLATNESS & THICKNESS

Flatness : MAX 0.7mm



Fig 1. Measuring point

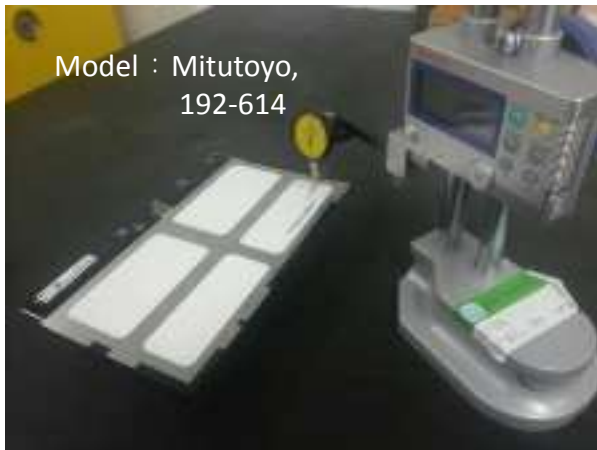

Fig 2. Hight Gauge



Fig 3. Pointer pressure



Measurement methods :

1. Device

Marble platform ; Height Gauge; Dial Gauge ; weight(155g)

2.Method

1. Installed the Dial Gauge on Height Gauge

In accordance with the Horizontal and vertical setting

2. Zero adjustment for Height Gauge

---Marble platform chassis as the base, then Plus pressure 0g,
Pointer the next frame comparison '0'. If pointer touch the ground,
adjusted to "0 Setting.

--- Adjustment cycle: every measurement

3. Weight height measurement : Measured with Micrometer

According to this test-point as shown in the Fig1

--- Adjustment cycle : every PLI

4. Place the product on the platform as shown in the Fig2

--- Place the measuring point weights for reading Height Gauge

--- Measuring the weight center height on test point

--- Record the measured values when Dial Gauge pointer to '0' ,
then subtracted weight height value .

5. Repeat the test 4

Remark :

Place weights on the platform because the back of the LCM is not perfectly flat (because of : PCB and frame).

Use weights on a specific location 9 point as shown as Fig 2 .

LCM will be placed completely horizontal position.



Thickness : 2.4+/-0.2mm



Fig 3. Measuring Equipment



Fig 4. Measuring point

1. Device

Calipers shown as Fig3

2.Method

Measured with Calipers According to this test-point as shown in the Fig4. Point 8 is the thickest location with PCB and the Maximum is 4.4mm .

LCD Thickness : 2.4+/-0.2mm



17.0 EDID TAB

EDID Table					
Address (HEX)	Function	Hex	Dec	Input values.	Notes
00	Header	00	0	0	EDID Header
01		FF	255	255	
02		FF	255	255	
03		FF	255	255	
04		FF	255	255	
05		FF	255	255	
06		FF	255	255	
07		00	0	0	
08	ID Manufacturer Name	09	9	1010	ID = 1010
09		E5	229		
0A	ID Product Code	F2	242		
0B		03	3		
0C	32-bit serial No.	00	0		
0D		00	0		
0E		00	0		
0F		00	0		
10	Week of manufacture	01	1	1	
11	Manufacture	19	25		
12	EDID Structure Ver.	01	1	1	EDID Ver 1.0
13	EDID revision #	04	4	4	EDID Rev. 0.4
14	Video input definition	95	149	-	
15	Max H image size	16	22	22	22 cm (Approx)
16	Max V image size	0E	14	14	14 cm (Approx)
17	Display Gamma	78	120	2.2	Gamma curve = 2.2
18	Feature support	0A	10		RGB display, Preferred Timming mode
19	Red/Green low bits	8A	138	-	Red / Green Low Bits
1A	Blue/White low bits	40	64	-	Blue / White Low Bits
1B	Red x high bits	99	153	0.600	Red (x) = 10011001 (0.6)
1C	Red y high bits	57	87	0.340	Red (y) = 01010111 (0.34)
1D	Green x high bits	50	80	0.315	Green (x) = 01010000 (0.315)
1E	Green y high bits	90	144	0.565	Green (y) = 10010000 (0.565)
1F	Blue x high bits	26	38	0.150	Blue (x) = 00100110 (0.15)
20	Blue y high bits	20	32	0.125	Blue (y) = 00100000 (0.125)
21	White x high bits	50	80	0.313	White (x) = 01010000 (0.313)
22	White y high bits	54	84	0.329	White (y) = 01010100 (0.329)



23	Established timing 1	00	0	-	
24	Established timing 2	00	0	-	
25	Established timing 3	00	0	-	
26	Standard timing #1	01	1		Not Used
27		01	1		
28	Standard timing #2	01	1		Not Used
29		01	1		
2A	Standard timing #3	01	1		Not Used
2B		01	1		
2C	Standard timing #4	01	1		Not Used
2D		01	1		
2E	Standard timing #5	01	1		Not Used
2F		01	1		
30	Standard timing #6	01	1		Not Used
31		01	1		
32	Standard timing #7	01	1		Not Used
33		01	1		
34	Standard timing #8	01	1		Not Used
35		01	1		
36	Detailed timing/monitor descriptor #1	87	135	75.6	75.59MHz MAIN clock
37		1D	29		
38		00	0	1280	Hor Active = 1280
39		EC	236	236	Hor Blanking = 236
3A		50	80	-	4 bits of Hor. Active + 4 bits of Hor. Blanking
3B		20	32	800	Ver Active = 800
3C		1F	31	31	Ver Blanking = 31
3D		30	48	-	4 bits of Ver. Active + 4 bits of Ver. Blanking
3E		0A	10	10	Hor Sync Offset = 10
3F		64	100	100	H Sync Pulse Width = 100
40		3C	60	3	V sync Offset = 3 line
41		00	0	12	V Sync Pulse width : 12 line
42		D9	217	217	Horizontal Image Size = 217 mm (Low 8 bits)
43		88	136	136	Vertical Image Size = 136 mm (Low 8 bits)
44		00	0	-	4 bits of Hor Image Size + 4 bits of Ver Image Size
45		00	0	0	Hor Border (pixels)
46	00	0	0	Vertical Border (Lines)	
47	1A	26		Refer to right table	



48	Detailed timing/monit or descriptor #2	BA	186	50.5	50.5MHz min clock
49		13	19		
4A		00	0	1280	Hor Active = 1280
4B		EC	236	236	Hor Blanking = 236
4C		50	80	-	4 bits of Hor. Active + 4 bits of Hor. Blanking
4D		20	32	800	Ver Active = 800
4E		1F	31	31	Ver Blanking = 31
4F		30	48	-	4 bits of Ver. Active + 4 bits of Ver. Blanking
50		0A	10	10	Hor Sync Offset = 10
51		64	100	100	H Sync Pulse Width = 100
52		3C	60	3	V sync Offset = 3 line
53		00	0	12	V Sync Pulse width : 12 line
54		D9	217	217	Horizontal Image Size = 217 mm (Low 8 bits)
55		88	136	136	Vertical Image Size = 136 mm (Low 8 bits)
56		00	0	-	4 bits of Hor Image Size + 4 bits of Ver Image Size
57		00	0	0	Hor Border (pixels)
58		00	0	0	Vertical Border (Lines)
59		1A	26		
5A		Detailed timing/monit or descriptor #3	00	0	Nvidia nvDPS Lowest refresh rate that does not caus e any visual/optical side effect
5B	00		0		
5C	00		0		
5D	00		0		
5E	00		0		
5F	00		0		
60	00		0		
61	00		0		
62	00		0		
63	00		0		
64	00		0		
65	00		0		
66	00		0		
67	00		0		
68	00	0			
69	00	0			
6A	00	0			
6B	00	0			



6C	Detailed timing/monit or descriptor #4	00	0	0	Detailed Timing Description #4
6D		00	0	0	Flag
6E		00	0	0	Reserved
6F		02	2		For Brightness Table and Power consumption
70		00	0	0	Flag
71		0C	12		PWM % [7:0] @ Step 0
72		3C	60		PWM % [7:0] @ Step 5
73		FF	255		PWM % [7:0] @ Step 10
74		0B	11		Nits [7:0] @ Step 0
75		3C	60		Nits [7:0] @ Step 5
76		6E	110		Nits [7:0] @ Step 10
77		19	25		Panel Electronics Power @32x32 Chess Pattern=
78		11	17		Backlight Power @60 nits=
79		1E	30		Backlight Power @Step 10=
7A		6E	110		Nits @ 100% PWM Duty =
7B		00	0	0	Flags
7C		00	0	0	Flags
7D	00	0	0	Flags	
7E	Extension flag	00	0		
7F	Checksum	70	112	-	