



SPECIFICATION FOR TFT LCD MODULE

CUSTOMER : _____

CUSTOMER MODULE : _____

HL MODEL : HG215FH008T01

Preliminary Specification

Final Specification

Customer Confirmation column:

Approved by : _____ Dept. : _____ Data : _____

Please return one of the copies of the specification with your signature to us within two weeks after you receive this document. If it is not returned, we will assume that you agree to the entire contents of this specification document.

Designed by	Checked by	Approved by



REVISION HISTORY

preliminary specification

Final specification

Revision No.	Page	Description of changes	Date	Prepared
Rev.P0		Initial Release	Aug.28.2020	



Contents

No.	Item	Page
1.0	General Description	4
2.0	Absolute Maximum Ratings	6
3.0	Electrical Specifications	7
4.0	Optical Specifications	9
5.0	Interface Connection	11
6.0	Signal Timing Specifications	15
7.0	Signal Timing Waveforms of Interface Signal	17
8.0	Input Signals, Display Colors & Gray Scale of Colors	19
9.0	Power Sequence	20
10.0	Mechanical Characteristics	21
11.0	Reliability Test	22
12.0	Handling& Cautions	23
13.0	Product Serial Number	24
14.0	Packing	25
15.0	Appendix	27



1.0 GENERAL DESCRIPTION

1.1 Introduction

HG215FH008T01 is a color active matrix TFT LCD module using amorphous silicon TFT's (Thin Film Transistors) as an active switching devices. This module has a 21.5 inch diagonally measured active area with FHD resolutions (1920 horizontal by 1080 vertical pixel array). Each pixel is divided into RED, GREEN, BLUE dots which are arranged in vertical stripe and this module can display 16.7M colors. The TFT-LCD panel used for this module is adapted for a low reflection and higher color type.

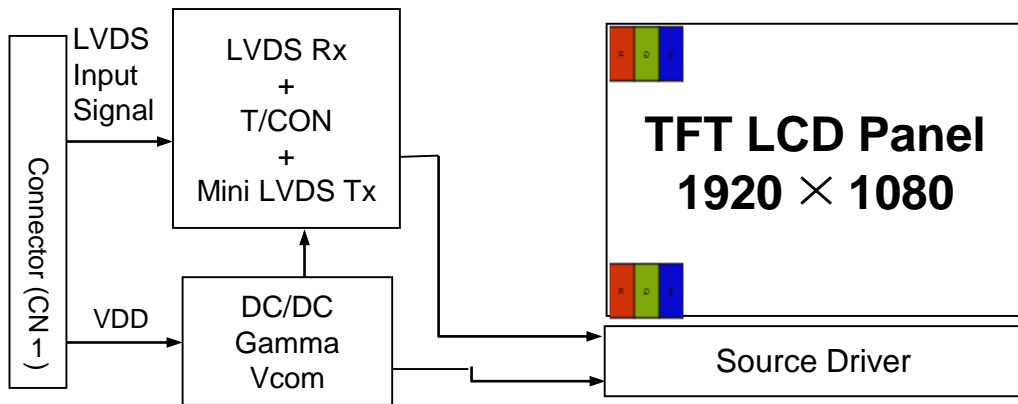

1.2 Features

- LVDS Interface with 2 pixel / clock
- High-speed response
- 0.5t Glass
- 6-bit (Hi-FRC) color depth, display 16.7M colors
- Incorporated edge type back-light (One Light Bar)
- High luminance and contrast ratio, low reflection and wide viewing angle
- DE (Data Enable) only
- RoHS/Halogen Free
- ES 7.0 compliant
- Gamma Correction
- Reverse type



1.3 Application

- Desktop Type of PC & Workstation Use
- Slim-Size Display for Stand-alone Monitor
- Display Terminals for Control System
- Monitors for Process Controller

1.4 General Specification

The followings are general specifications at the model HG215FH008T01.

<Table 1. General Specifications>

Parameter	Specification	Unit	Remarks
Active area	476.064(H) × 267.786(V)	mm	
Number of pixels	1920(H) × 1080(V)	pixels	
Pixel pitch	0.24795(H) x 0.24795(V)	mm	
Pixel arrangement	RGB Vertical stripe	-	
Display colors	16.7M	colors	
Display mode	Normally Black	-	
Dimensional outline	495.6(H) × 292.2(V) × 10.7(D) typ.	mm	Detail refer to drawing
Weight	1.97	Kg	
Bezel width (L/R/U/D)	7.9/7.9/10.5/10.5	mm	
Surface Treatment	Anti-glare, 3H	-	
Back-light	Lower side 1-LED Light bar Type	-	



2.0 ABSOLUTE MAXIMUM RATINGS

The followings are maximum values which, if exceed, may cause faulty operation or damage to the unit. The operational and non-operational maximum voltage and current values are listed in Table 2.

< Table 2. Absolute Maximum Ratings > [VSS=GND=0V]

Parameter	Symbol	Min.	Max.	Unit	Remarks
Power Supply Voltage	V_{DD}	-0.3	5.5	V	Ta = 25 °C
Logic Supply Voltage	V_{IN}	VSS-0.3	$V_{DD}+0.3$	V	
Operating Temperature	T_{OP}	0	+50	°C	1)
Storage Temperature	T_{ST}	-20	+60	°C	1)

Note : 1) Temperature and relative humidity range are shown in the figure below.
Wet bulb temperature should be 39 °C max. and no condensation of water.

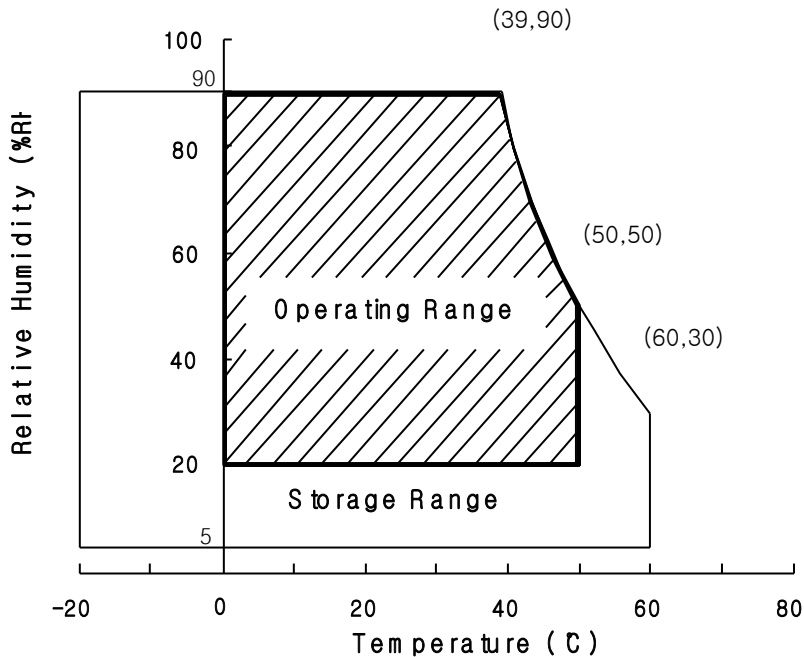



3.0 ELECTRICAL SPECIFICATIONS

3.1 Electrical Specifications

< Table 3. Electrical specifications >

[Ta = 25 ± 2 °C]

Parameter		Min.	Typ.	Max.	Unit	Remarks
Power Supply Voltage	V _{DD}	4.5	5.0	5.5	V	Note 1
Power Supply Current	I _{DD}	-	500	1200	mA	
In-Rush Current	I _{RUSH}	-	2.0	3	A	Note 2
Permissible Input Ripple Voltage	V _{RF}	-	-	300	mV	V _{DD} = 5.0V
High Level Differential Input Threshold Voltage	V _{IH}	-	-	+100	mV	
Low Level Differential Input Threshold Voltage	V _{IL}	-100	-	-	mV	
Differential input voltage	V _{ID}	200	-	600	mV	
Differential input common mode voltage	V _{cm}	1.0	1.2	1.5		V _{IH} =100mV, V _{IL} =-100mV
LED Voltage	V _L	2.8	3.0	3.2	V	
LED Channel Voltage	V _L	-	72	76.8	V	
LED Channel Current	I _L		80		mA	
LED Lifetime		30,000	-	-	Hrs	I _L =80 mA
Power Consumption	P _D	-	2.5	6	W	
	P _{BL}	-	17.3	18.4	W	I _L =80mA, Note 3
	P _{total}	-	19.8	24.4	W	

Notes : 1. The supply voltage is measured and specified at the interface connector of LCM.

The current draw and power consumption specified is for VDD=5.0V, Frame rate=75Hz. Test Pattern of power supply current

- a) Typ : Color Bar pattern
- b) Max : Gray level 255 pattern

2. Duration of rush current is about 2 ms and rising time of VDD is 520 μs ± 20 %

3. Calculated value for reference (V_L × I_L) × 3(channel) excluding driver loss. (LED Light bar: 24S3P)



Parameter		Min.	Typ.	Max.	Unit	Remarks
LED Light Bar Input Voltage Per Input Pin	V _{PIN}	-	72	76.8	V	Duty 100%
LED Light Bar Input Current Per Input Pin	I _{PIN}		80		mA	Note1,2,
LED Power Consumption	P _{BL}	-	17.3	18.4	W	Note 3
LED Life-Time	-	30,000	-		Hrs	Note 4

LED bar consists of 72 LED packages,3 strings(parallel)*24packages(serial)

Note1: There are one light bar ,and the specified current is input LED chip 100% duty current

Note2: The sense current of each input pin is 80mA

Note3: $P_{BL}=3 \text{ Input pins} \times V_{PIN} \times I_{PIN}$

Note4: The lifetime is determined as the time at which luminance of LED become 50% of the initial brightness or not normal lighting at I_{PIN}=80mA on condition of continuous operating at 25 ± 2 °C



4.0 OPTICAL SPECIFICATION

4.1 Overview

The test of Optical specifications shall be measured in a dark room (ambient luminance ≤ 1 lux and temperature = $25 \pm 2^\circ\text{C}$) with the equipment of Luminance meter system (Goniometer system and TOPCONE PR730) and test unit shall be located at an approximate distance 50cm from the LCD surface at a viewing angle of θ and Φ equal to 0° . We refer to $\theta_{\Phi=0}$ ($=\theta_3$) as the 3 o'clock direction (the "right"), $\theta_{\Phi=90}$ ($=\theta_{12}$) as the 12 o'clock direction ("upward"), $\theta_{\Phi=180}$ ($=\theta_9$) as the 9 o'clock direction ("left") and $\theta_{\Phi=270}$ ($=\theta_6$) as the 6 o'clock direction ("bottom"). While scanning θ and/or Φ , the center of the measuring spot on the Display surface shall stay fixed. The measurement shall be executed after 30 minutes warm-up period. VDD shall be 5.0V +/-10% at 25°C . Optimum viewing angle direction is 6 'clock.

4.2 Optical Specifications

[VDD = 5.0V, Frame rate = 60Hz, Clock = 74MHz, $I_{BL} = 240\text{mA}$, $T_a = 25 \pm 2^\circ\text{C}$]

< Table 4. Module Optical >

Parameter		Symbol	Condition	Min.	Typ.	Max.	Unit	Remark
Viewing Angle range	Horizontal	Θ_3	CR > 10	85	89	-	Deg.	Note 1
		Θ_9		85	89	-	Deg.	
	Vertical	Θ_{12}		85	89	-	Deg.	
		Θ_6		85	89	-	Deg.	
Luminance Contrast ratio		CR	$\Theta = 0^\circ$ (Center) Normal Viewing Angle	700	1000			Note 2
Luminance of White		Y_w		480	500	-	cd/m ²	Note 3
White luminance uniformity		ΔY		75	-	-	%	Note 4
Reproduction of color	White	W_x		0.283	0.313	0.343	-	Note 5
		W_y	0.299	0.329	0.359	-		
	Red	R_x	0.608	0.638	0.668	-		
		R_y	0.327	0.357	0.387	-		
	Green	G_x	0.284	0.314	0.344	-		
		G_y	0.608	0.638	0.668	-		
	Blue	B_x	0.122	0.152	0.182	-		
		B_y	0.038	0.068	0.098	-		
Response Time	GTG	T_g		14	20	ms	Note 6	
Cross Talk		CT		-	-	2.0	%	Note 7



Note :

1. Viewing angle is the angle at which the contrast ratio is greater than 10. The viewing are determined for the horizontal or 3, 9 o'clock direction and the vertical or 6, 12 o'clock direction with respect to the optical axis which is normal to the LCD surface.
2. Contrast measurements shall be made at viewing angle of $\theta = 0^\circ$ and at the center of the LCD surface. Luminance shall be measured with all pixels in the view field set first to white, then to the dark (black) state. (See FIGURE 1 shown in Appendix) Luminance Contrast Ratio (CR) is defined mathematically.

$$CR = \frac{\text{Luminance when displaying a white raster}}{\text{Luminance when displaying a black raster}}$$

3. Center Luminance of white is defined as the LCD surface. Luminance shall be measured with all pixels in the view field set first to white. This measurement shall be taken at the locations shown in FIGURE 2 for a total of the measurements per display.
4. The White luminance uniformity on LCD surface is then expressed as :
 $\Delta Y = (\text{Minimum Luminance of 9points} / \text{Maximum Luminance of 9points}) * 100$
 (See FIGURE 2 shown in Appendix).
5. The color chromaticity coordinates specified in Table 5. shall be calculated from the spectral data measured with all pixels first in red, green, blue and white. Measurements shall be made at the center of the panel.
6. Response time T_g is the average time required for display transition by switching the input signal as below table and is based on Frame rate $f_V = 60\text{Hz}$ to optimize. Each time in below table is defined as appendix Figure 3 and shall be measured by switching the input signal for “any level of gray(bright)” and “any level of gray(dark)”.

Measured Response Time	Target																
	0	15	31	47	63	79	95	111	127	143	159	175	191	207	223	239	255
0																	
15																	
31																	
47																	
63																	
79																	
95																	
111																	
127																	
143																	
159																	
175																	
191																	
207																	
223																	
239																	
255																	

7. Cross-Talk of one area of the LCD surface by another shall be measured by comparing the luminance (Y_A) of a 25mm diameter area, with all display pixels set to a gray level, to the luminance (Y_B) of that same area when any adjacent area is driven dark. (See FIGURE 4 shown in Appendix).



5.0 INTERFACE CONNECTION.

5.1 Electrical Interface Connection

5.1.1 LED Light Bar

-LED connector : 3707K-Q06N-08X manufactured by Entry

< Table 5. LED Light Bar >

Pin No	Symbol	Description
1	IRLED1	LED current sense for string1
2	IRLED2	LED current sense for string2
3	VLED	LED power supply
4	VLED	LED power supply
5	NC	NC
6	IRLED3	LED current sense for string3



5.2 Electrical Interface Connection

- CN11 Module Side Connector : UJU IS100-L30R-C23or Equivalent
User Side Connector : JAE FI-X30H or Equivalent

Pin No	Symbol	Function	Remark
1	RX00-	Negative Transmission data of Pixel 0 (ODD)	
2	RX00+	Positive Transmission data of Pixel 0 (ODD)	
3	RX01-	Negative Transmission data of Pixel 1 (ODD)	
4	RX01+	Positive Transmission data of Pixel 1 (ODD)	
5	RX02-	Negative Transmission data of Pixel 2 (ODD)	
6	RX02+	Positive Transmission data of Pixel 2 (ODD)	
7	BIST	Bist function	Note1
8	RXOC-	Negative Transmission Clock (ODD)	
9	RXOC+	Positive Transmission Clock (ODD)	
10	RX03-	Negative Transmission data of Pixel 3 (ODD)	
11	RX03+	Positive Transmission data of Pixel 3 (ODD)	
12	RXE0-	Negative Transmission data of Pixel 0 (EVEN)	
13	RXE0+	Positive Transmission data of Pixel 0 (EVEN)	
14	GND	Power Ground	
15	RXE1-	Negative Transmission data of Pixel 1 (EVEN)	
16	RXE1+	Positive Transmission data of Pixel 1 (EVEN)	
17	GND	Power Ground	
18	RXE2-	Negative Transmission data of Pixel 2 (EVEN)	
19	RXE2+	Positive Transmission data of Pixel 2 (EVEN)	
20	RXEC-	Negative Transmission Clock (EVEN)	
21	RXEC+	Positive Transmission Clock (EVEN)	
22	RXE3-	Negative Transmission data of Pixel 3 (EVEN)	
23	RXE3+	Positive Transmission data of Pixel 3 (EVEN)	
24	GND	Power Ground	Note 2
25	CTL	*Reserved for LCD manufacturer's(CTL_DVR)	
26	CE	*Reserved for LCD manufacturer's(CE_DVR)	
27	NC		
28	VDD	Power Supply: +5V	
29	VDD		
30	VDD		

Note 1 : H: White-Black-Red-Green-Blue Pattern Aging, L:Black pattern , when no LVDS signal

Note2: This pin should be connected with GND.



5.2 LVDS Interface (Tx; THC63LVDF83A or Equivalent)

5.2.1 LVDS Interface

	Input Signal	Transmitter		Interface		MV215FHB-N30 (CN11)	Remark
		Pin No.	Pin No.	System (Tx)	TFT-LCD (Rx)	Pin No.	
L V D S	OR0	51	48 47	OUT0- OUT0+	RX00- RX00+	1	
	OR1	52					
	OR2	54					
	OR3	55					
	OR4	56					
	OR5	3					
	OG0	4	46 45	OUT1- OUT1+	RX01- RX01+	3	
	OG1	6					
	OG2	7					
	OG3	11					
	OG4	12					
	OG5	14					
	OB0	15	42 41	OUT2- OUT2+	RX02- RX02+	5	
	OB1	19					
	OB2	20					
	OB3	22					
	OB4	23					
	OB5	24					
	Hsync	27	38 37	OUT3- OUT3+	RX03- RX03+	6	
	Vsync	28					
	DE	30					
	MCLK	31	40 39	OUT- CLK	CLK- RXO	8 9	
	OR6	50	38 37	OUT+ OUT3- OUT3+	CLK+ RX03- RX03+	10	
	OR7	2					
	OG6	8					
	OG7	10					
	OB6	16					
	OB7	18					
RSVD	25						



5.2 Data Input Format

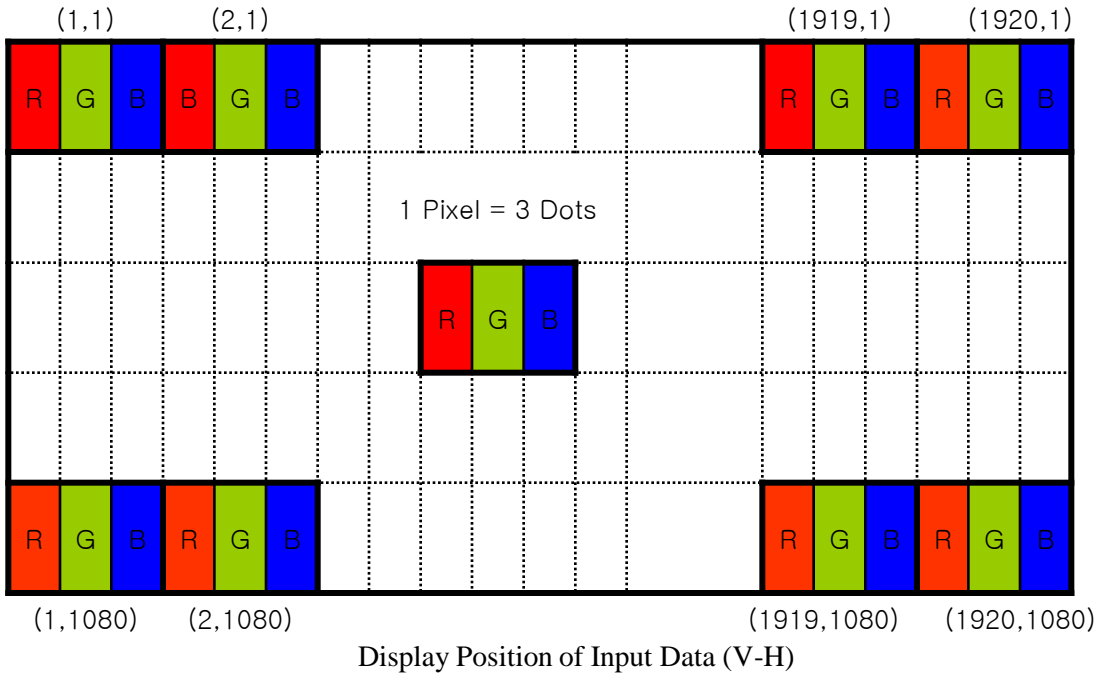

5.3 Back-light Interface Connection

-LED connector : 3707K-S06N-08X manufactured by Entry

Pin	Function
1	Channel 1 Current Feedback
2	Channel 2 Current Feedback
3	LED Power Supply
4	LED Power Supply
5	Channel3 Current Feedback
6	Channel4 Current Feedback



6.0 SIGNAL TIMING SPECIFICATION

6.1 The HG215FH008T01 is operated by the DE only.

Item	Symbols		Min	Typ	Max	Unit
DCLK	Period	tCLK	11.1	13.47	16.7	ns
	Frequency	-	60	74	90	MHz
Horizontal Display Term	Period	tHP	1050	1100	1120	tCLK
	Horizontal Valid	tHV	960	960	960	tCLK
	Horizontal Blank	tHB	90	140	160	tCLK
	Frequency	fH	64	67	83	KHz
Vertical Display Term	Period	tVP	1110	1125	1251	tHP
	Vertical Valid	tVV	1080	1080	1080	tHP
	Vertical Blank	tVB	30	45	171	tHP
	Frequency	fV	50	60	75	Hz
LVDS Receiver clock	Input spread spectrum ratio	SSr	-3	-	+3	%

Note 1 : This DCLK range at last line of V-blanking should be set in 0~987.



6.2 LVDS Rx Interface Timing Parameter

The specification of the LVDS Rx interface timing parameter is shown in Table 4.

<Table 4. LVDS Rx Interface Timing Specification>

Item	Symbol	Min	Typ	Max	Unit	Remark
CLKIN Period	tRCIP	11.1	13.47	16.7	nsec	
Input Data 0	tRIP1	-0.4	0.0	+0.4	nsec	
Input Data 1	tRIP0	tRCIP/7-0.4	tRCIP/7	tRCIP/7+0.4	nsec	
Input Data 2	tRIP6	2 × tRCIP/7-0.4	2 × tRCIP/7	2 × tRCIP/7+0.4	nsec	
Input Data 3	tRIP5	3 × tRCIP/7-0.4	3 × tRCIP/7	3 × tRCIP/7+0.4	nsec	
Input Data 4	tRIP4	4 × tRCIP/7-0.4	4 × tRCIP/7	4 × tRCIP/7+0.4	nsec	
Input Data 5	tRIP3	5 × tRCIP/7-0.4	5 × tRCIP/7	5 × tRCIP/7+0.4	nsec	
Input Data 6	tRIP2	6 × tRCIP/7-0.4	6 × tRCIP/7	6 × tRCIP/7+0.4	nsec	

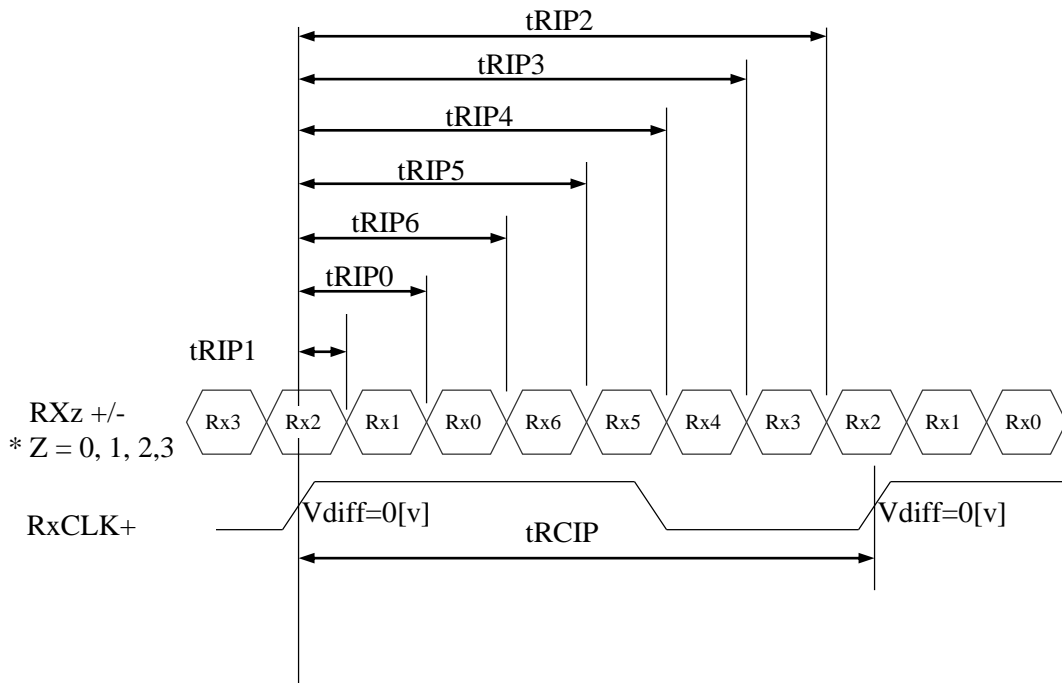

* $V_{diff} = (RXz+) - (RXz-), \dots, (RXCLK+) - (RXCLK-)$



7.0 SIGNAL TIMING WAVEFORMS OF INTERFACE SIGNAL

7.1 Sync Timing Waveforms

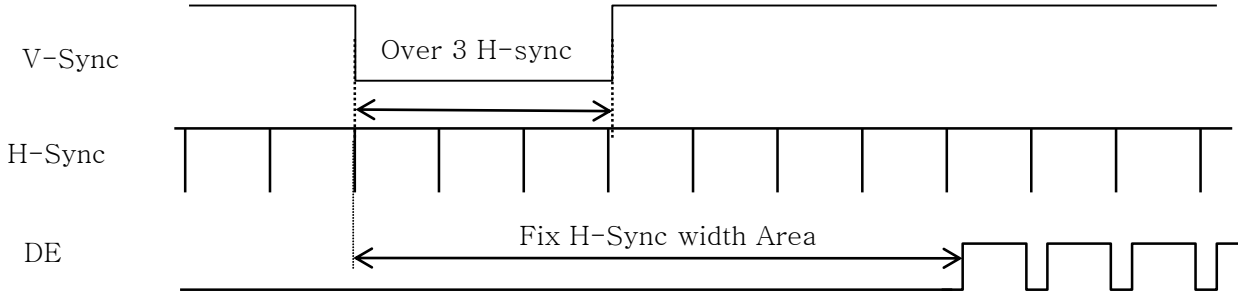

- 1) Need over 3 H-sync during V-Sync Low
- 2) Fix H-Sync width from V-Sync falling edge to first rising edge

7.2 Vertical Timing Waveforms

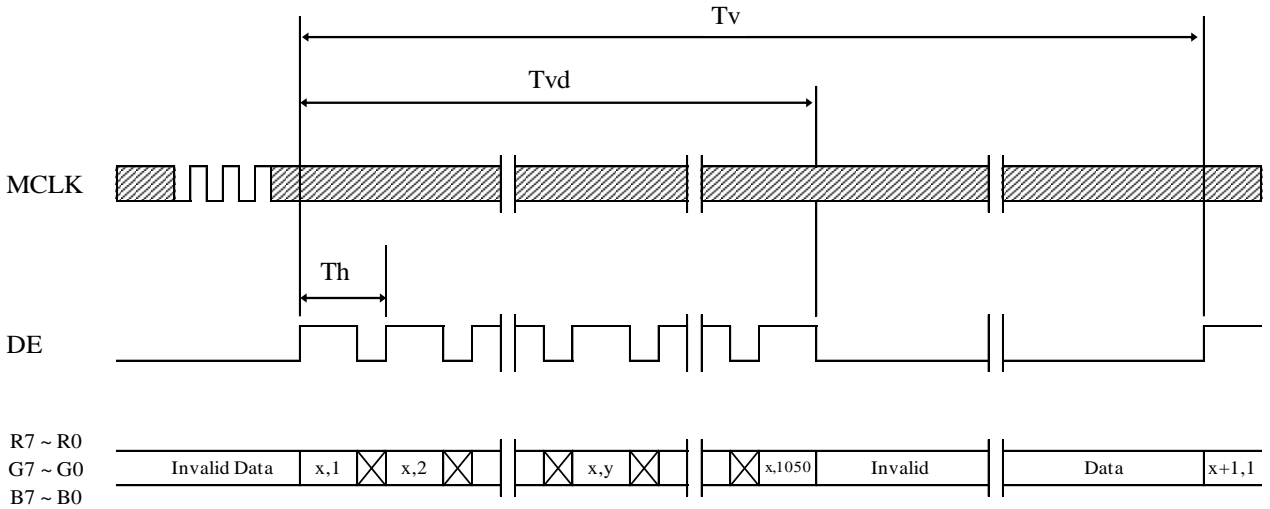



7.3 Horizontal Timing Waveforms

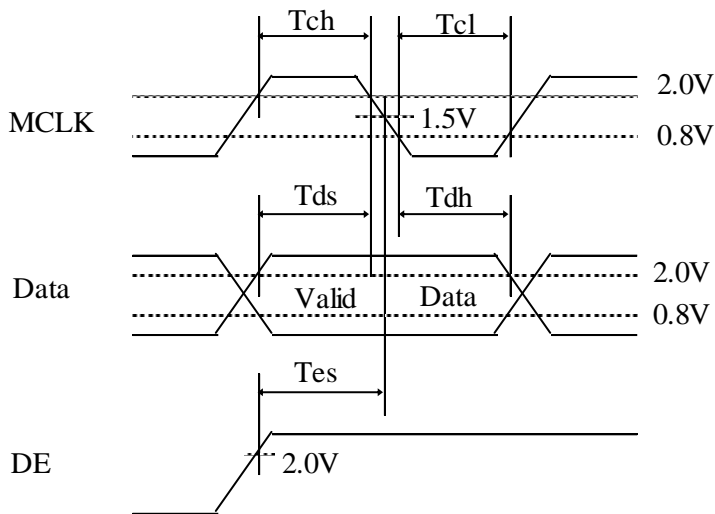
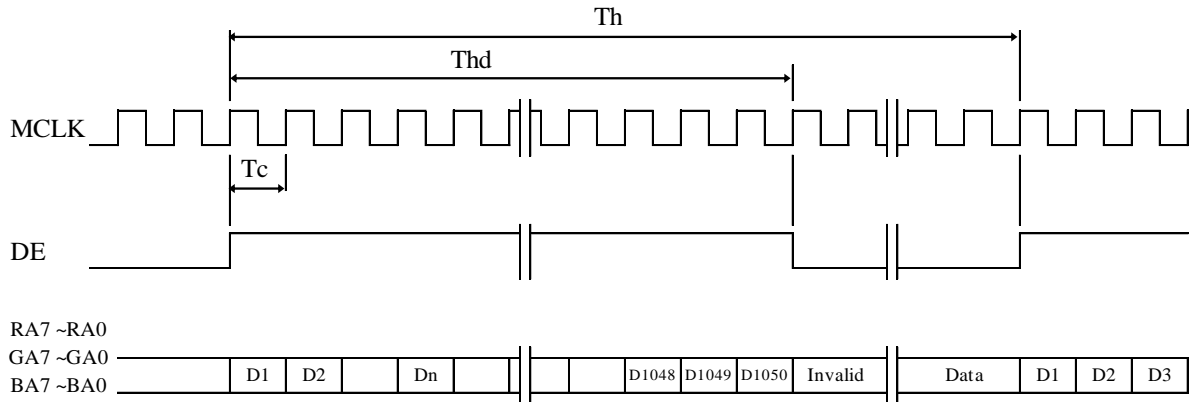



8.0 INPUT SIGNALS, BASIC DISPLAY COLORS & GRAY SCALE OF COLORS

Color & Gray Scale		RED DATA								GREEN DATA								BLUE DATA							
		R7	R6	R5	R4	R3	R2	R1	R0	G7	G6	G5	G4	G3	G2	G1	G0	B7	B6	B5	B4	B3	B2	B1	B0
Basic Colors	Black	0	0	0	0	0	0	0	0	0	0	0	0	0	0	0	0	0	0	0	0	0	0	0	0
	Blue	0	0	0	0	0	0	0	0	0	0	0	0	0	0	0	0	1	1	1	1	1	1	1	1
	Green	0	0	0	0	0	0	0	0	1	1	1	1	1	1	1	1	0	0	0	0	0	0	0	0
	Cyan	0	0	0	0	0	0	0	0	1	1	1	1	1	1	1	1	1	1	1	1	1	1	1	1
	Red	1	1	1	1	1	1	1	1	0	0	0	0	0	0	0	0	0	0	0	0	0	0	0	0
	Magenta	1	1	1	1	1	1	1	1	0	0	0	0	0	0	0	0	1	1	1	1	1	1	1	1
	Yellow	1	1	1	1	1	1	1	1	1	1	1	1	1	1	1	1	0	0	0	0	0	0	0	0
	White	1	1	1	1	1	1	1	1	1	1	1	1	1	1	1	1	1	1	1	1	1	1	1	1
Gray Scale of RED	Black	0	0	0	0	0	0	0	0	0	0	0	0	0	0	0	0	0	0	0	0	0	0	0	
	△	0	0	0	0	0	0	1	0	0	0	0	0	0	0	0	0	0	0	0	0	0	0	0	
	Darker	0	0	0	0	0	0	1	0	0	0	0	0	0	0	0	0	0	0	0	0	0	0	0	
	△	↑								↓															
	▽	↓								↑															
	Brighter	1	1	1	1	1	1	0	1	0	0	0	0	0	0	0	0	0	0	0	0	0	0	0	0
	▽	1	1	1	1	1	1	1	0	0	0	0	0	0	0	0	0	0	0	0	0	0	0	0	0
	Red	1	1	1	1	1	1	1	1	0	0	0	0	0	0	0	0	0	0	0	0	0	0	0	0
Gray Scale of GREEN	Black	0	0	0	0	0	0	0	0	0	0	0	0	0	0	0	0	0	0	0	0	0	0	0	
	△	0	0	0	0	0	0	0	0	0	0	0	0	0	0	1	0	0	0	0	0	0	0	0	
	Darker	0	0	0	0	0	0	0	0	0	0	0	0	0	1	0	0	0	0	0	0	0	0	0	
	△	↑								↓															
	▽	↓								↑															
	Brighter	0	0	0	0	0	0	0	0	1	1	1	1	1	1	0	1	0	0	0	0	0	0	0	0
	▽	0	0	0	0	0	0	0	0	1	1	1	1	1	1	1	0	0	0	0	0	0	0	0	0
	Green	0	0	0	0	0	0	0	0	1	1	1	1	1	1	1	1	0	0	0	0	0	0	0	0
Gray Scale of BLUE	Black	0	0	0	0	0	0	0	0	0	0	0	0	0	0	0	0	0	0	0	0	0	0	0	
	△	0	0	0	0	0	0	0	0	0	0	0	0	0	0	0	0	0	0	0	0	0	0	1	
	Darker	0	0	0	0	0	0	0	0	0	0	0	0	0	0	0	0	0	0	0	0	0	1	0	
	△	↑								↓															
	▽	↓								↑															
	Brighter	0	0	0	0	0	0	0	0	0	0	0	0	0	0	0	0	1	1	1	1	1	1	0	1
	▽	0	0	0	0	0	0	0	0	0	0	0	0	0	0	0	0	1	1	1	1	1	1	1	0
	Blue	0	0	0	0	0	0	0	0	0	0	0	0	0	0	0	0	1	1	1	1	1	1	1	1
Gray Scale of WHITE	Black	0	0	0	0	0	0	0	0	0	0	0	0	0	0	0	0	0	0	0	0	0	0	0	
	△	0	0	0	0	0	0	1	0	0	0	0	0	0	0	1	0	0	0	0	0	0	0	1	
	Darker	0	0	0	0	0	0	1	0	0	0	0	0	0	1	0	0	0	0	0	0	0	1	0	
	△	↑								↓															
	▽	↓								↑															
	Brighter	1	1	1	1	1	0	1	1	1	1	1	1	1	0	1	1	1	1	1	1	1	0	1	
	▽	1	1	1	1	1	1	0	1	1	1	1	1	1	1	0	1	1	1	1	1	1	1	0	
	White	1	1	1	1	1	1	1	1	1	1	1	1	1	1	1	1	1	1	1	1	1	1	1	



9.0 POWER SEQUENCE

To prevent a latch-up or DC operation of the LCD module, the power on/off sequence shall be as shown in below

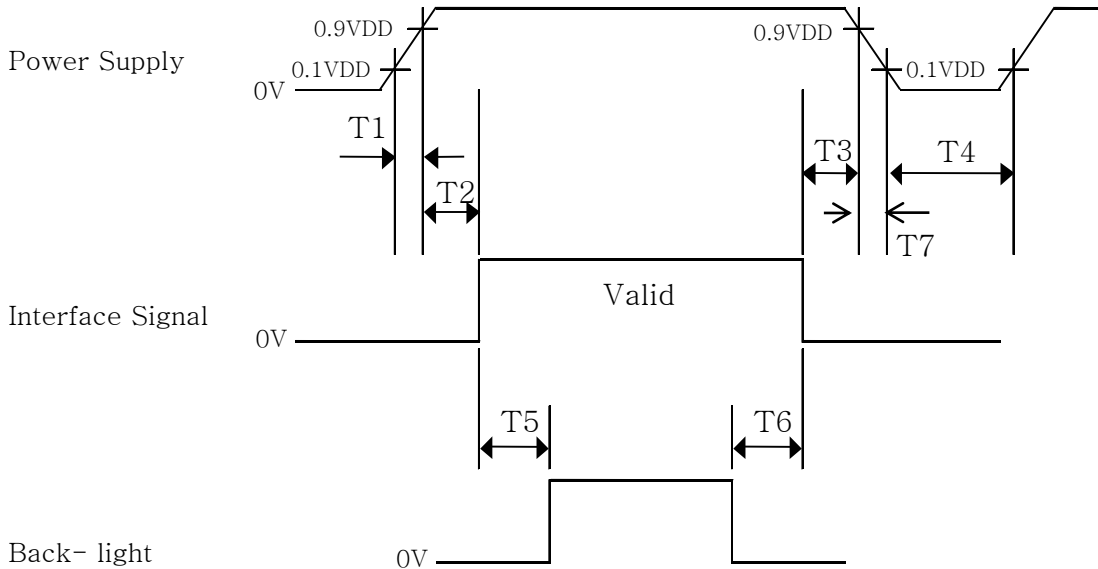

- $0.5 \text{ ms} \leq T1 \leq 10 \text{ ms}$
- $0 \leq T2 \leq 50 \text{ ms}$
- $0 \leq T3 \leq 50 \text{ ms}$
- $1 \text{ sec} \leq T4$
- $200 \text{ ms} \leq T5$
- $200 \text{ ms} \leq T6$

Notes:

1. When the power supply VDD is 0V, keep the level of input signals on the low or keep high impedance.
2. Do not keep the interface signal high impedance when power is on.
3. Back Light must be turn on after power for logic and interface signal are valid.
4. T7 decreases smoothly, there is none re-bouncing voltage.
5. During changing the resolution or mode changing, the logic power/ back-light/interface signal should be turned off as shown above; after the changing, power on as shown above.



10.0 MECHANICAL CHARACTERISTICS

10.1 Dimensional Requirements

FIGURE 5 (located in Appendix) shows mechanical outlines for the model HG215FH008T01. Other parameters are shown in Table 8.

<Table 8. Dimensional Parameters>

Parameter	Specification	Unit
Dimensional outline	495.6(H) × 292.2(V) × 10.7(D) type	mm
Weight	1.97	Kg
Active area	476.064(H) × 267.786(V)	mm
Pixel pitch	0.24795(H) x 0.24795(V)	mm
Number of pixels	1920(H) × 1080(V) (1 pixel = R + G + B dots)	pixels
Back-light	Lower side 1-LED Light bar Type	

10.2 Mounting

See FIGURE 5 . (shown in Appendix)

10.3 Anti-Glare and Polarizer Hardness.

The surface of the LCD has an anti-glare coating to minimize reflection and a coating to reduce scratching.

10.4 Light Leakage

There shall not be visible light from the back-lighting system around the edges of the screen as seen from a distance 50cm from the screen with an overhead light level of 350lux.



11.0 RELIABILITY TEST

The Reliability test items and its conditions are shown in below.

<Table 9 Reliability Test Parameters >

No	Test Items	Conditions	
1	High temperature storage test	Ta = 60 °C, 240 hrs	
2	Low temperature storage test	Ta = -20 °C, 240 hrs	
3	High temperature & high humidity operation test	Ta = 50 °C, 80%RH, 240hrs	
4	High temperature operation test	Ta = 50 °C, 240hrs	
5	Low temperature operation test	Ta = 0°C, 240hrs	
6	Thermal shock	Ta = -20 °C ↔ 60 °C (0.5 hr), 100 cycle	
7	Vibration test (non-operating)	Frequency	Random, 10 ~ 300 Hz, 30 min/Axis
		Gravity / AMP	1.5 Grms
		Period	X, Y, Z 30 min
8	Shock test (non-operating)	Gravity	50G
		Pulse width	11msec, sine wave
		Direction	± X, ± Y, ± Z Once for each
9	Electro-static discharge test	Air : 150 pF, 330Ω, 15 KV	Contact : 150 pF, 330Ω, 8 KV
10	Altitude test	Non Operating: 40000 ft, -10°C / 24 Hr, 25°C / 24 Hr, -10°C / 24 Hr	
		Operating: 15000 ft, 0°C / 24 Hr, 25°C / 24 Hr, 50°C / 24 Hr	



12.0 HANDLING & CAUTIONS

- (1) Cautions when taking out the module
 - Pick the pouch only, when taking out module from a shipping package.
- (2) Cautions for handling the module
 - As the electrostatic discharges may break the LCD module, handle the LCD module with care. Peel a protection sheet off from the LCD panel surface as slowly as possible.
 - As the LCD panel and back - light element are made from fragile glass material, impulse and pressure to the LCD module should be avoided.
 - As the surface of the polarizer is very soft and easily scratched, use a soft dry cloth without chemicals for cleaning.
 - Do not pull the interface connector in or out while the LCD module is operating.
 - Put the module display side down on a flat horizontal plane.
 - Handle connectors and cables with care.
- (3) Cautions for the operation
 - When the module is operating, do not lose CLK, ENAB signals. If any one of these signals is lost, the LCD panel would be damaged.
 - Obey the supply voltage sequence. If wrong sequence is applied, the module would be damaged.
- (4) Cautions for the atmosphere
 - Dew drop atmosphere should be avoided.
 - Do not store and/or operate the LCD module in a high temperature and/or humidity atmosphere. Storage in an electro-conductive polymer packing pouch and under relatively low temperature atmosphere is recommended.
- (5) Cautions for the module characteristics
 - Do not apply fixed pattern data signal to the LCD module at product aging.
 - Applying fixed pattern for a long time may cause image sticking.
- (6) Other cautions
 - Do not disassemble and/or re-assemble LCD module.
 - Do not re-adjust variable resistor or switch etc.
 - When returning the module for repair or etc., Please pack the module not to be broken. We recommend to use the original shipping packages.



13.0 PRODUCT SERIAL NUMBER

HG215FH008T01

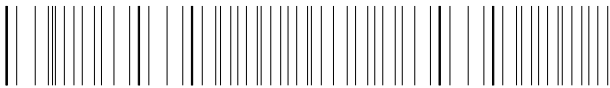

XXXX XXXXXXXXXXXXXXXXXXXXXXXX

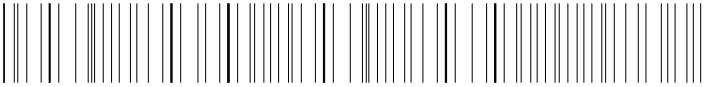

XX-XXXXXX-XXXXX-XXX-XXXX

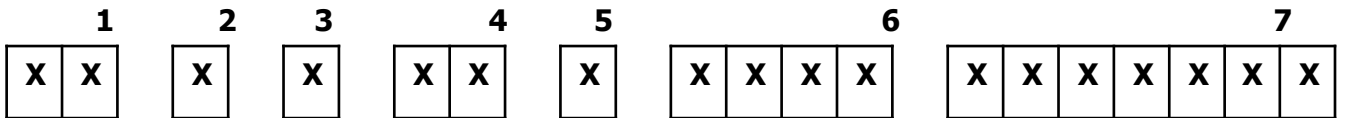

- 1. Control Number
- 2. Rank / Grade
- 3. Line Classification
- 4. Year (2001 : 01, 2002 : 02, ...)

- 5. Month (1,2,3, ... , 9, X, Y, Z)
- 6. Internal Use
- 7. Serial Number



14.0 Packing

14.1 Packing Order

-Put 1Pcs EPO Bottom into the box

-Put each module into a PE bag
-Put 12Pcs MDL into the box

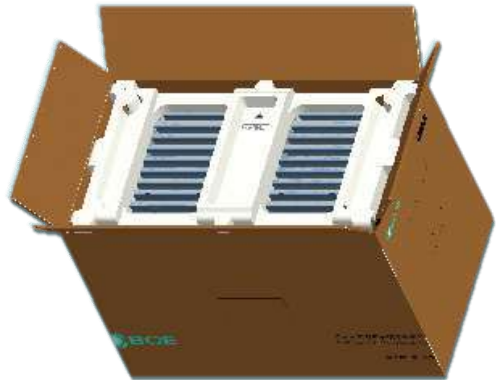
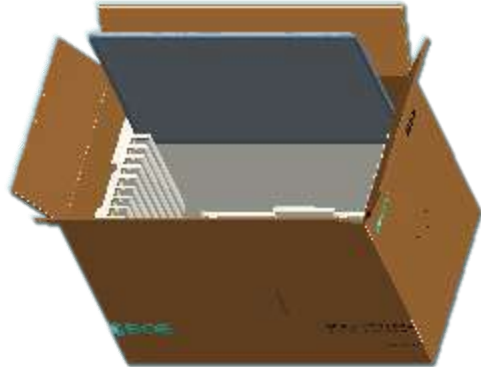
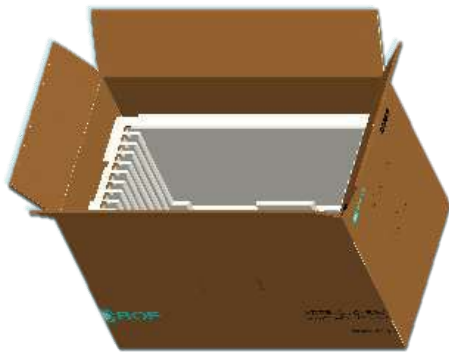

-Put 1 Pcs EPO cover in and seal the box.

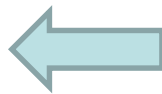
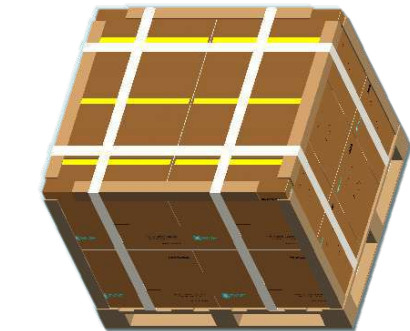

-Put the boxes on the Pallet

12boxes/Pallet:6boxes per layer, total 2 layers

18boxes/Pallet:6Boxes per layer, total 3 layers

-Place paper corners and wrap film around the boxes

-Pack with 4 packing belts



14.3 Packing Specification and Note

Item	Specification			Remark
	Q'ty	Dimension(mm)	Weight (kg)	
Panel	1	495.6(H) × 292.2(V) × 10.7(D) typ.	1.97	-
Cushion	-	-	-	-
Box	1	547(L)×322(W)×384(H)	0.483	without Panel & cushion
Packing Box	12pcs/Box	563(L)×338(W)×390(H)	23.8	with panel & cushion
Pallet	1	1140(L)×1080(W)×130(H)	18	-
Packing Pallet	12Box/Pallet	1140(H)×1080(H)×910(H)	306	-
	18Box/Pallet	1140(H)×1080(H)×1300(H)	466	-



15.0 APPENDIX

Figure 1. Measurement Set Up

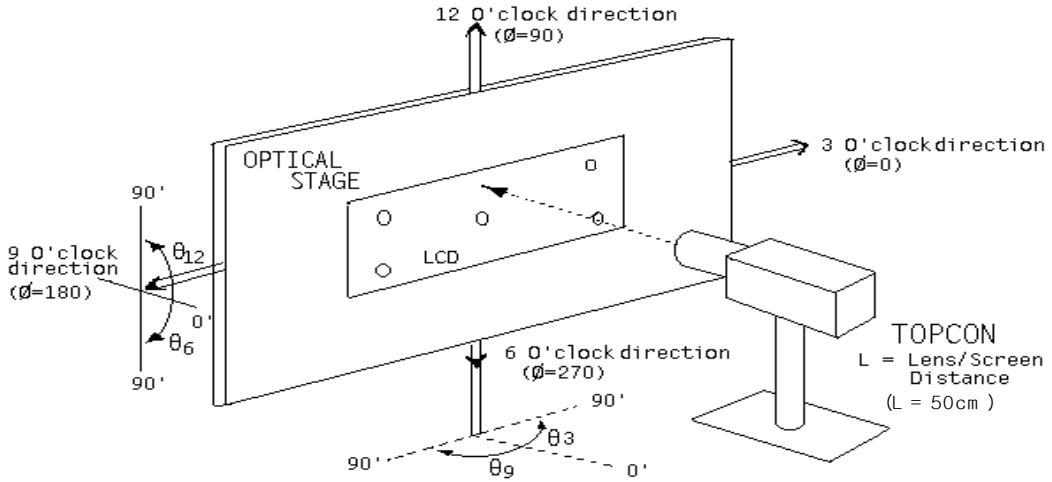

Figure 2. White Luminance and Uniformity Measurement Locations (9 points)

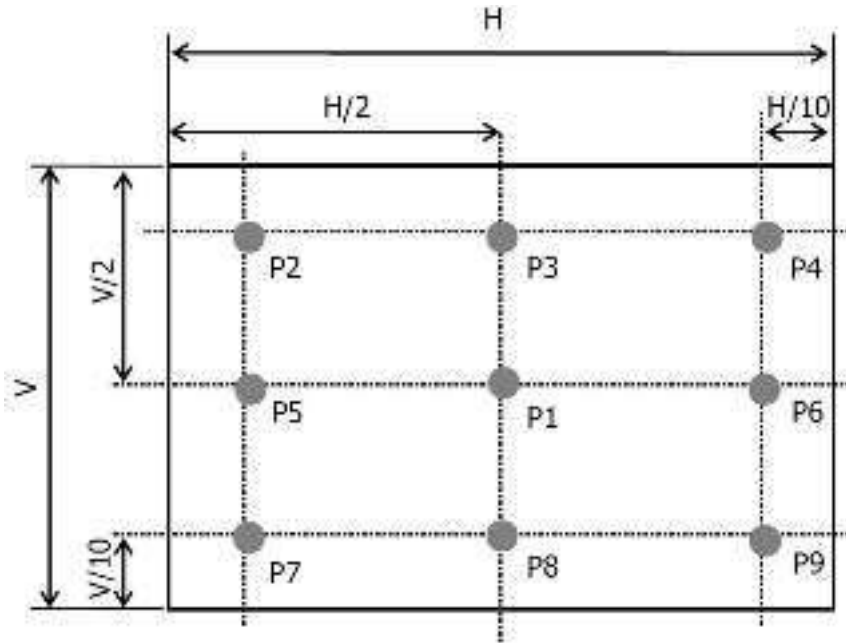



Figure 3. Response Time Testing

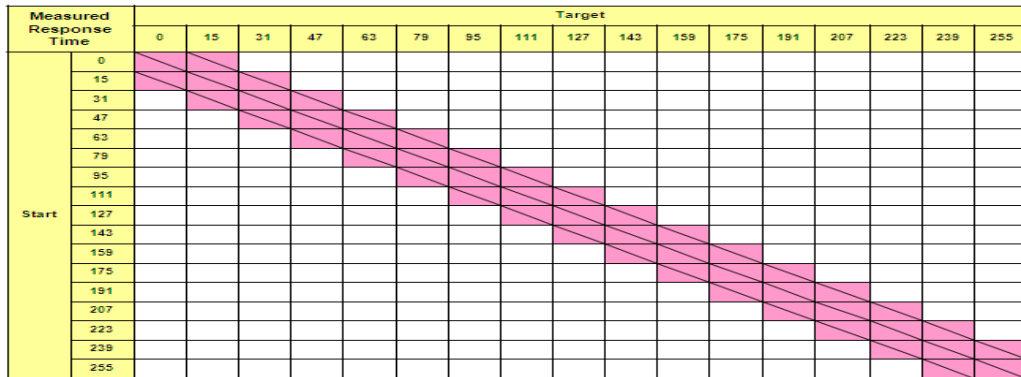
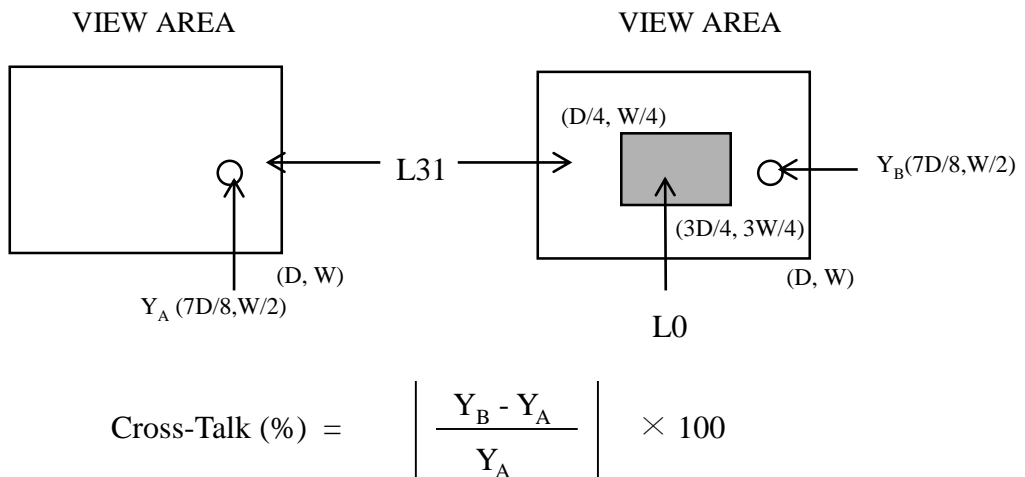

Figure 4. Cross Modulation Test Description



Where: Y_A = Initial luminance of measured area (cd/m²)
 Y_B = Subsequent luminance of measured area (cd/m²)
 The location measured will be exactly the same in both patterns



Figure 5. TFT-LCD Module Outline Dimensions (Front view)

由 Autodesk 教育版产品制作

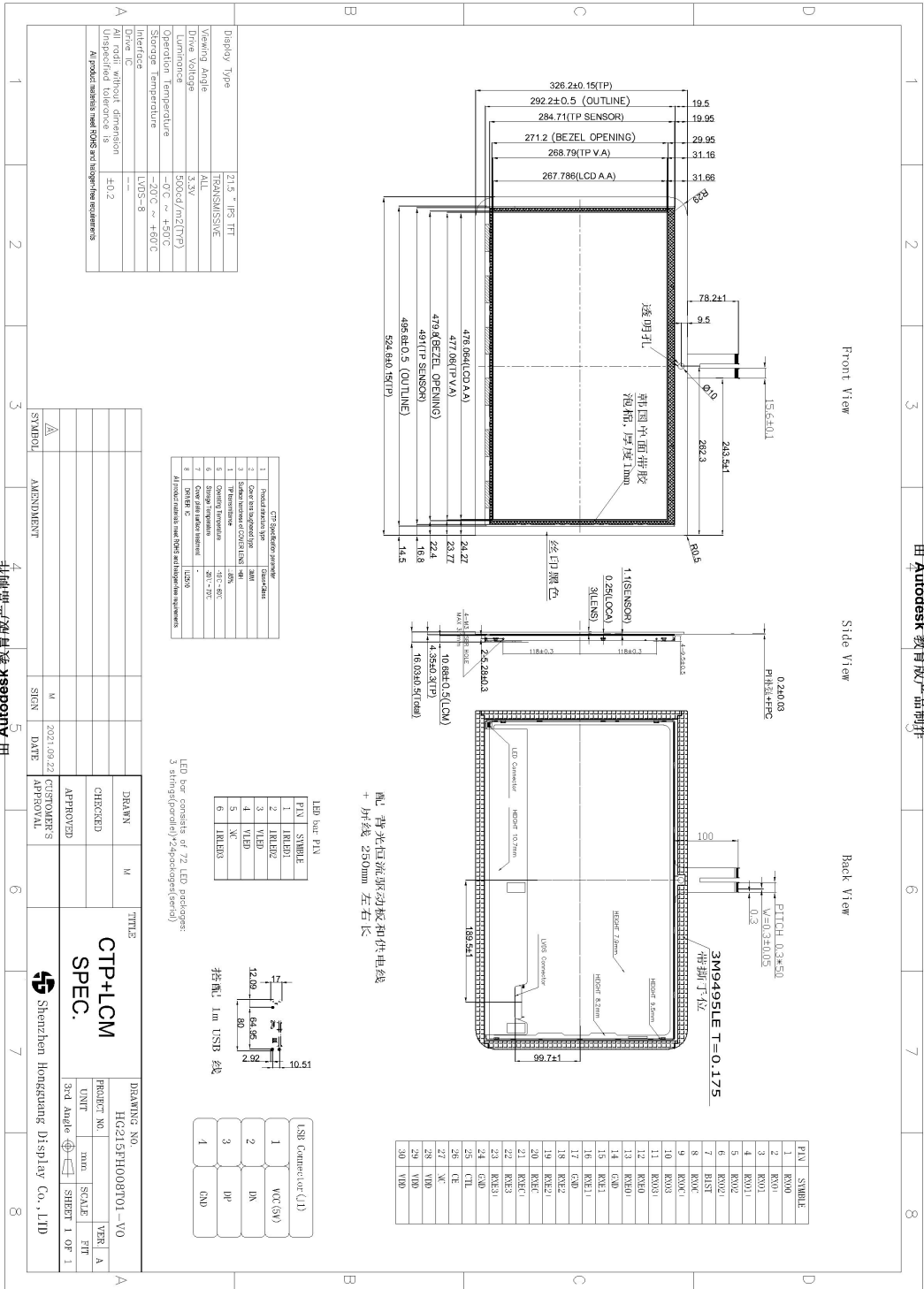



Figure 6. TFT-LCD Module Outline Dimensions (Rear view)

